

Balusters .....	169
Rails .....	174
Installation Aids .....	175
Newel Posts .....	176
Post Accessories .....	178
Stone Balustrade Systems .....	180

The logo for FYPON, featuring the word "FYPON" in a bold, black, serif font. A blue wave-like graphic element is positioned to the left of the letter "Y".A photograph of a white balustrade system installed on a brick wall. The balustrade features a series of white, fluted balusters supported by a white base. A brick pillar on the left holds a black lantern-style light fixture. The background shows a clear blue sky and some green foliage.

## Define Your Boundaries

### Balustrade Systems

This design accent is excellent for defining a living space. With Fypon® balustrade systems, you can transform any ordinary porch, patio or balcony into an impressive, sophisticated space. With distinctive styles and sizes available, Fypon balustrades are made from corrosion-resistant parts that keep their beauty with little maintenance. Most fasteners remain totally hidden to provide a clean, classic appearance from any view. Made of the same durable polyurethane material featured in all our products, most balustrade parts are also structurally reinforced. For easy installation and ordering, complete systems are available with all the essential components. **For installation instructions, please visit [www.fypon.com](http://www.fypon.com).**

Products shown: BTR12X96, BBR12X96, BAL6X24AY, NP12X48, PST13S13P

## How to Use This Section

The products in this section of the catalog are organized by style and then size. Once you determine the style of balustrade system desired, you can find the right size for your project with all the parts and accessories needed to complete the system, conveniently grouped together.

## How to Order

### Balustrade Systems\*\*

Fypon smooth balustrades are available in three systems: 5", 7" and 12". This size designates the width of the top and bottom rail.

In addition to these three sizes, we offer a stone-textured system, which has a 6" wide top and bottom rail.

### Planning Your Layout

#### Balusters

For each baluster, we have noted a center spacing dimension. This is the maximum center-to-center distance between balusters that does not allow a 4" ball to pass through at any point. The number of balusters you need can be found by dividing the rail span, in inches, by the center spacing dimension shown under each part.

**NOTE:** When dividing gives you a fractional result, always round up to the next whole number as shown in the example.

#### Rail Installation Kits

Each rail section (span between two newel posts) will require two rail installation kits (BRK). Rail installation kits will connect both ends of one rail to a newel post, with the exception of BRK12ANGLBKT. This kit connects both ends of one section, requiring only one kit per section.

**NOTE:** Fypon rail installation kits will not work on stair applications. Top and bottom rails do not come pre-drilled.

#### Newel Posts

Each newel post will require one newel post installation kit (NPK) to anchor the base of the post, as well as any post tops, balls or trim collars desired.

### Balustrade System Accessories

Balustrade system accessories are available to help achieve your desired look. All balustrade accessories are unattached and must be ordered separately.

### Columns and Porch Posts

A variety of structural post options are available to customize your balustrade system. Choose from structural porch posts or structural columns in the Porch Posts, Columns and Post Wrap section, beginning on page 182.

**NOTE:** When using porch posts with any railing system, make sure that the base height of the post can accommodate the overall height of your railing system.

### Custom Products

To request a unique custom product design, please contact the Fypon Custom Product Sales Department at 855.397.6647. You may also fill out our Custom Quote Request Form, which can be obtained at [www.fypon.com/products/custom.asp](http://www.fypon.com/products/custom.asp), or contact the Fypon Customer Service Department at 800.446.3040.

\* Loctite® PL Premium® is owned by Henkel Corporation.

\*\* Always consult the local building code authority to determine suitability of products to meet specific project requirements.



#### Remember to Order Adhesive

A urethane-based adhesive **must** be used on all joint surfaces. See page 190 to order Loctite® PL Premium® Adhesive.\*

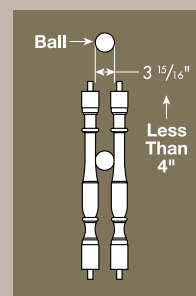

Example:

BAL3X20CC – Requires 5" on center spacing  
 Rail Span ÷ Center Spacing = No. of Balusters Needed

$$96" \div 5" = 19.2$$

(Round up to 20)

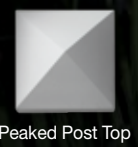

Peaked Post Top



Trim Collar



Baluster Reinforced



Baluster Top Rail Reinforced

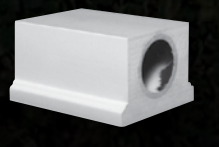

Baluster Bottom Rail Reinforced

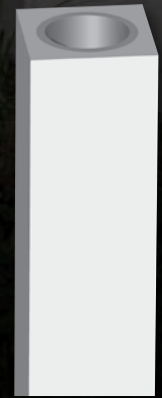

Newel Post Reinforced



Load-Bearing Porch Post Reinforced

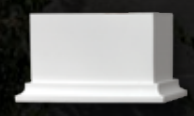

Rail Support Block

# Ashley Baluster

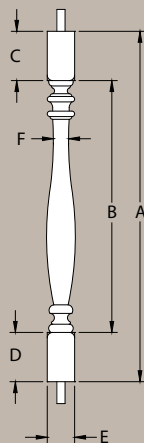

Part Number	Balustrade System	A	B	C	D	E	F	Maximum Center-to-Center Distance
BAL2X10AY	5"	10"	6"	2"	2"	2 1/4"	1 3/4"	5 7/8"
BAL2.5X15AY	5"	15"	9"	3"	3"	2 1/2"	1 7/8"	5 27/32"
BAL3X20AY	5"	20"	15"	2 1/2"	2 1/2"	2 1/2"	1 7/16"	5 3/8"
BAL3X24AY	5"	24"	15"	1 1/2"	4 1/2"	2 1/2"	1 3/8"	5 3/8"
BAL3X28AY	5"	28"	19"	4 5/8"	4 5/8"	2 1/2"	1 3/8"	5 11/32"
BAL3X32AY	5"	32"	23"	4 1/2"	4 1/2"	2 1/2"	1 3/8"	5 11/32"
BAL3X36AY	5"	36"	24"	6"	6"	2 1/2"	1 1/4"	5 3/16"
BAL4X24AY	7"	24"	15"	4 1/2"	4 1/2"	4 1/2"	3 1/2"	7 3/8"
BAL5X20AY	7"	20"	13"	3 1/2"	3 1/2"	4 1/2"	3 1/2"	7 21/32"
BAL5X24AY	7"	24"	17"	3 1/2"	3 1/2"	4 1/2"	3 7/16"	7 3/8"
BAL5X28AY	7"	28"	19"	4 1/2"	4 1/2"	4 1/2"	3 13/32"	7 11/32"
BAL5X32AY	7"	32"	22 15/16"	4 1/2"	4 1/2"	4 1/2"	3 3/8"	7 11/32"
BAL6X24AY	12"	24"	15"	4 1/2"	4 1/2"	5 1/2"	4 7/16"	8 3/8"

NOTE: Baluster images shown above may not be an accurate representation of every size within each category. For additional line art images, please visit [www.fypon.com](http://www.fypon.com).



# Classic Baluster

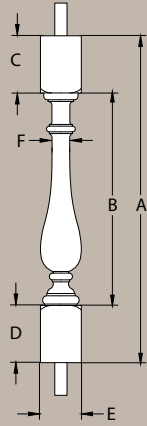

Part Number	Balustrade System	A	B	C	D	E	F	Maximum Center-to-Center Distance
BAL3X20CC	5"	20"	13"	3 1/2"	3 1/2"	2 1/2"	1 3/32"	5"
BAL3X24CC	5"	24"	17"	3 1/2"	3 1/2"	2 1/2"	1 1/32"	4 31/32"
BAL3X28CC	5"	28"	21"	3 1/2"	3 1/2"	2 1/2"	1"	4 15/16"
BAL3X32CC	5"	32"	25"	3 1/2"	3 1/2"	2 1/2"	1 3/32"	5 1/32"
BAL5X20CC	7"	20"	10"	5"	5"	5"	3 19/32"	7 21/32"
BAL5X24CC	7"	24"	14"	5"	5"	5"	3 19/32"	7 21/32"
BAL5X28CC	7"	28"	18"	5"	5"	5"	3 9/16"	7 1/2"
BAL5X30CC	7"	30 1/2"	20 1/2"	5"	5"	5"	3 19/32"	7 17/32"
BAL5X32CC	7"	32"	22"	5"	5"	5"	3 9/16"	7 1/2"
BAL4X27CCOB	7"	27"	19"	4"	4"	4 1/4"	1 27/32"	5 13/16"
BAL4X31CCOB	7"	31"	23"	4"	4"	4 1/4"	1 25/32"	5 11/16"
BAL5X28CCOB	7"	28"	21 1/8"	3 3/8"	3 3/8"	4 1/2"	2"	5 29/32"
BAL7X24CC	12"	24"	12"	6"	6"	7"	5 17/32"	9 15/32"
BAL7X28CC	12"	28"	16"	6"	6"	7"	5 15/32"	9 3/8"
BAL7X28CCOB	12"	28"	21 3/16"	3 13/32"	3 13/32"	7"	3 9/16"	7 17/32"

NOTE: Baluster images shown above may not be an accurate representation of every size within each category. For additional line art images, please visit [www.fypon.com](http://www.fypon.com).

# Logan Baluster

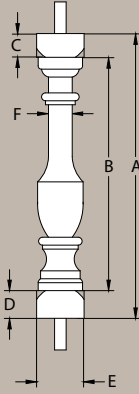

^ Cannot be used for stair applications.

Part Number	Balustrade System	A	B	C	D	E	F	Maximum Center-to-Center Distance
BAL3X18LN	5"	18"	12"	3"	3"	3"	1 1/2"	5 19/32"
BAL3X18LN0B	5"	18"	15"	1 1/2"	1 3/4"	3"	1 1/2"	5 7/16"
BAL3X20LN	5"	20"	14"	3"	3"	3"	1 1/2"	5 7/16"
BAL3X24LN	5"	24"	18"	3"	3"	3"	1 1/2"	5 7/16"
BAL3X28LN	5"	28"	22"	3"	3"	3"	1 1/2"	5 7/16"
BAL3X32LN	5"	32"	26"	3"	3"	3"	1 1/2"	5 7/16"
BAL3X36LN	5"	36"	30"	3"	3"	3"	1 1/2"	5 7/16"
BAL4X24LN^	7"	24"	20 1/4"	1 3/4"	2"	3 1/2"	2"	5 15/16"
BAL5X31LN	7"	31"	24"	3 1/2"	3 1/2"	4 1/2"	2"	5 15/16"
BAL5X31LN0B	7", 12"	31"	24"	2 1/2"	4 1/2"	5"	2 1/2"	5 11/16"

NOTE: Baluster images shown above may not be an accurate representation of every size within each category. For additional line art images, please visit [www.fypon.com](http://www.fypon.com).

# Rosedale Baluster

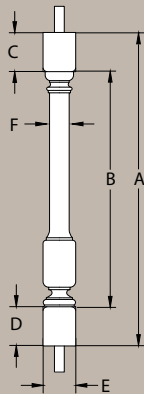

Part Number	Balustrade System	A	B	C	D	E	F	Maximum Center-to-Center Distance
BAL3X24RL	5"	24"	18"	3"	3"	2 1/2"	1 1/2"	5 7/16"
BAL5X16RL	7", 12"	16"	8"	4"	4"	4 1/2"	3 5/16"	7 1/4"
BAL5X20RL	7", 12"	20"	12"	4"	4"	4 1/2"	2 23/32"	6 21/32"
BAL5X20RLOB	7", 12"	20 1/4"	14 3/4"	2 1/2"	3"	4 1/2"	2 1/2"	6 7/16"
BAL5X24RL	7", 12"	24"	16"	4"	4"	4 1/2"	2 23/32"	6 21/32"
BAL5X24RLOB	7", 12"	24"	17"	3"	4"	4 1/2"	2 1/4"	6 3/16"
BAL5X28RL	7", 12"	28"	20"	4"	4"	4 1/2"	2 23/32"	6 21/32"
BAL7X25RL	12"	24 1/2"	17"	3"	4 1/2"	6 3/4"	3"	6 15/16"
BAL7X28RL	12"	28"	16"	6"	6"	6 3/4"	4 31/32"	8 29/32"

NOTE: Baluster images shown above may not be an accurate representation of every size within each category. For additional line art images, please visit [www.fypon.com](http://www.fypon.com).

## Square Baluster

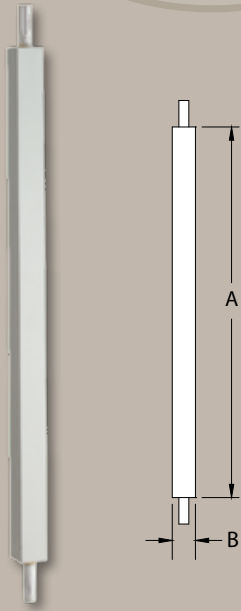

Part Number	Balustrade System	Height (A)	Width (B)	Maximum Center-to-Center Distance
BAL2X16SQ	5"	16"	1 3/4"	5 11/16"
BAL2X20SQ	5"	20"	1 3/4"	5 11/16"
BAL2X24SQ	5"	24"	1 3/4"	5 11/16"
BAL2X28SQ	5"	28"	1 3/4"	5 11/16"
BAL2X32SQ	5"	32"	1 3/4"	5 11/16"
BAL2X48SQ	5"	48"	1 3/4"	5 11/16"
BAL5X28SQ	7", 12"	28"	4 7/8"	8 13/16"

NOTE: Baluster images shown above may not be an accurate representation of every size within each category. For additional line art images, please visit [www.fypon.com](http://www.fypon.com).

## Beaumont Baluster

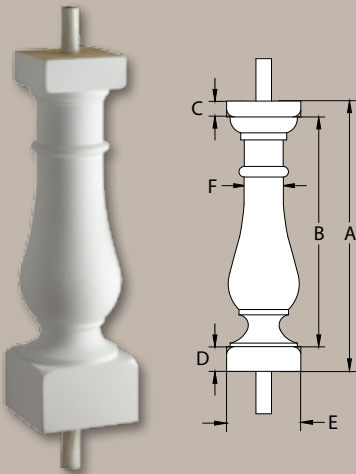

Part Number	Balustrade System	A	B	C	D	E	F	Maximum Center-to-Center Distance
BAL4X22BE	7"	22"	19 1/8"	1 1/8"	1 3/4"	4"	2 3/8"	6 9/32"
BAL5X19BE	7", 12"	19 1/8"	16 1/4"	1 1/8"	1 3/4"	5 1/4"	2 3/4"	6 23/32"
BAL5X22BE	7", 12"	22"	16 1/8"	2 1/8"	3 3/4"	5"	3 3/16"	7 5/32"
BAL5X31BE	12"	31"	24 7/16"	2 17/32"	4 1/32"	5 3/4"	2 7/8"	6 27/32"
BAL5X34BE	12"	33 7/8"	24 7/16"	3 31/32"	5 15/32"	5 3/4"	2 7/8"	6 7/8"
BAL6X22BE	12"	21 7/8"	16 1/8"	2 1/16"	3 11/16"	6 3/16"	4"	7 15/16"

NOTE: Baluster images shown above may not be an accurate representation of every size within each category. For additional line art images, please visit [www.fypon.com](http://www.fypon.com).

# Woodruff Baluster

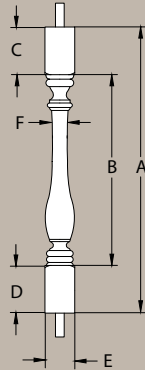

Part Number	Balustrade System	A	B	C	D	E	F	Maximum Center-to-Center Distance
BAL3X18WF	5"	18"	10"	4"	4"	2 1/2"	1 3/8"	5 17/32"
BAL3X20WF	5"	20"	12"	4"	4"	2 1/2"	1 9/32"	5 7/32"
BAL3X20WFOB	5"	20 1/4"	12 1/2"	3 3/4"	4"	2 3/4"	1 9/16"	5 1/2"
BAL3X24WF	5"	24"	16"	4"	4"	2 1/2"	1 7/32"	5 5/32"
BAL3X28WF	5"	28"	20"	4"	4"	2 1/2"	1 7/32"	5 5/32"
BAL3X32WF	5"	32"	24"	4"	4"	2 1/2"	1 7/32"	5 5/32"
BAL3X36WF	5"	36"	28"	4"	4"	2 1/2"	1 7/32"	5 5/32"
BAL5X20WF	7", 12"	20"	12"	4"	4"	4 1/2"	3 1/4"	7 3/16"
BAL5X24WF	7", 12"	24"	16"	4"	4"	4 1/2"	3 9/32"	7 5/32"
BAL5X28WF	7", 12"	28"	20"	4"	4"	4 1/2"	3 7/32"	7 5/32"
BAL5X32WF	7", 12"	32"	24"	4"	4"	4 1/2"	3 7/32"	7 5/32"
BAL6X24WF	12"	24"	16"	4"	4"	5 1/2"	4 7/32"	8 1/8"
BAL6X28WF	12"	28"	20"	4"	4"	5 1/2"	4 7/32"	8 5/32"

NOTE: Baluster images shown above may not be an accurate representation of every size within each category. For additional line art images, please visit [www.fypon.com](http://www.fypon.com).

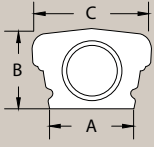
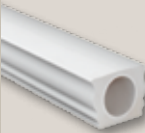
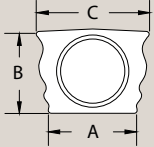
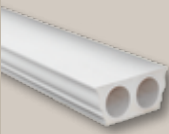
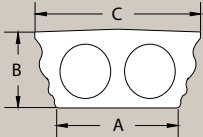

# Top & Bottom Straight Rails

Top Rail	Part Number	Balustrade System	Length	A	B	C	
	BTR5X96	5"	96"	3 1/4"	3 1/8"	4 5/8"	
	BTR5X144^	5"	144"	3 1/4"	3 1/8"	4 5/8"	
	BTR7X96	7"	96"	5 1/2"	5 1/4"	7"	
	BTR7X120^	7"	120"	5 1/2"	5 1/4"	7"	
	BTR7X144^	7"	144"	5 1/2"	5 1/4"	7"	
	BTR12X96	12"	96"	9"	5 1/4"	11 7/8"	
	BTR12X120^	12"	120"	9"	5 1/4"	11 7/8"	
	BTR12X144^	12"	144"	9"	5 1/4"	11 7/8"	

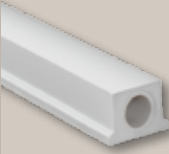
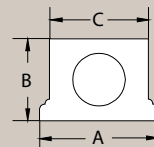
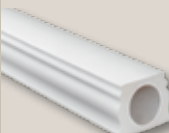
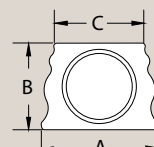
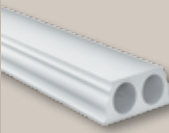
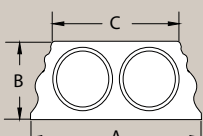

^ Maximum rail span distance for field applications is 96".

Bottom Rail	Part Number	Balustrade System	Length	A	B	C	
	BBR5X96	5"	96"	4 1/2"	3 1/8"	3 3/4"	
	BBR5X144^	5"	144"	4 1/2"	3 1/8"	3 3/4"	
	BBR7X96	7"	96"	7"	5 1/4"	5 1/2"	
	BBR7X120^	7"	120"	7"	5 1/4"	5 1/2"	
	BBR7X144^	7"	144"	7"	5 1/4"	5 1/2"	
	BBR12X96	12"	96"	11 7/8"	5 1/4"	9"	
	BBR12X120^	12"	120"	11 7/8"	5 1/4"	9"	
	BBR12X144^	12"	144"	11 7/8"	5 1/4"	9"	

^ Maximum rail span distance for field applications is 96".

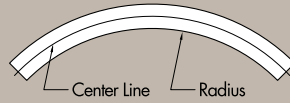
# Radius Rails

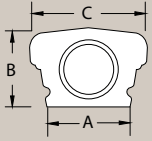

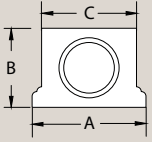
	Part Number	Balustrade System	Radius	A	B	C	
 Top	BTRR5X60	5"	60"	3 1/4"	3 1/8"	4 5/8"	
 Bottom	BBRR5X60	5"	60"	4 1/2"	3 1/8"	3 3/4"	

NOTE: Center line is approximately 9 1/4" in length.

# Installation Aids

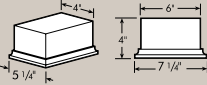
Part Number	Balustrade System	Installation Notes	
 RSB4X4X6 Rail Support Block	5", 7", 12"	Install under the bottom rail at a span of 48" or less. Dimensions: 4" x 4" x 7 1/4" (may be trimmed for height)	
BRK5 Rail Installation Kit	5"	Connects both ends of one 5" top or bottom rail to support structure. Order two kits per section. <b>Kit Contents:</b> (2) Angle Brackets & Mounting Hardware	
BRK6-7 Rail Installation Kit	7"	Connects both ends of one 7" top or bottom rail to support structure. Order two kits per section. <b>Kit Contents:</b> (2) Angle Brackets & Mounting Hardware	
BRK12 Rail Installation Kit	12"	Connects both ends of one 12" top or bottom rail to 12" newel post or other support. Order two kits per section. <b>Kit Contents:</b> (4) Angle Brackets & Mounting Hardware	
BRK12ANGLBKT Rail Installation Kit	12"	Connects both ends of one 12" top or bottom rail to 13" newel post only. Order two kits per section. <b>Kit Contents:</b> (2) Angle Brackets & Mounting Hardware	

## Plain Newel Post

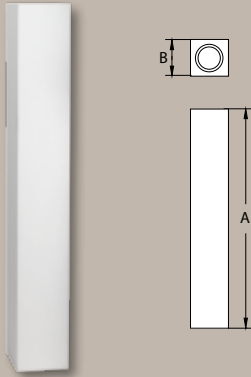

Part Number	Balustrade System	A	B	Accessories
NP6X48	5"	48"	5 1/2"	PST6X6FP PST7X7F PST7X7P TC6
NP8X48	7"	48"	7 1/2"	

NOTE: Post tops shown are sold separately.

## Decorative Newel Post

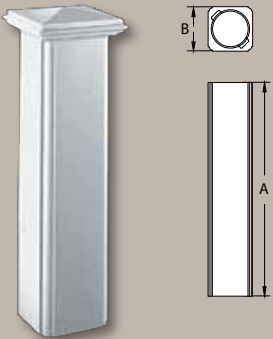

Part Number	Balustrade System	A	B	Accessories
NP10X48	7"	48"	10"	PST11X11FP PST12X12F

NOTE: Post tops shown are sold separately.

## Corner Panel Newel Post

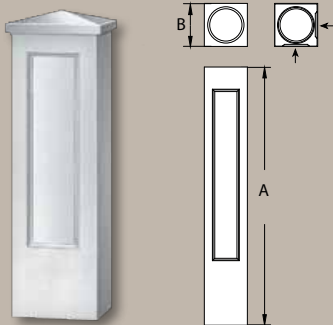

Part Number	Balustrade System	A	B	Accessories
NPCP8X48	7"	48"	8"	PST8X8FP PST10X10F PST10X10P TC8
NPCP13X48	12"	48"	12 1/2"	PST13X13FP PST14X14F PST14X14P

NOTE: Post tops shown are sold separately.

## Straight Panel Newel Post

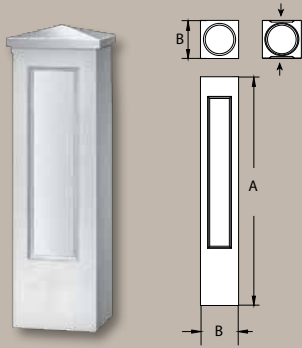

Part Number	Balustrade System	A	B	Accessories
NPSP8X48	7"	48"	8"	PST9X9FP PST10X10F PST10X10P TC8-8
NPSP13X48	12"	48"	12 1/2"	PST13X13FP PST14X14F PST14X14P

NOTE: Post tops shown are sold separately.

## Plain Newel Post

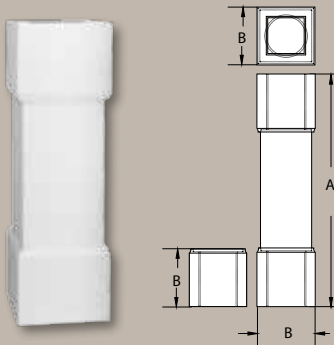

Part Number	Balustrade System	A	B	Accessories
NP12X48	12 "	48"	12"	PST13X13F PST13X13P







NOTE: Post tops shown are sold separately.

## Installation Kits

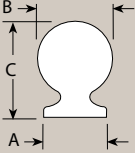
Newel post installation kits are sold separately from the newel posts. Fasteners to mount steel base plate to the floor surface are not provided.

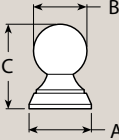

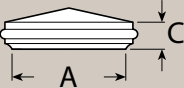

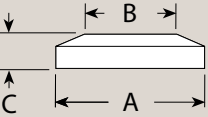





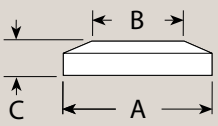



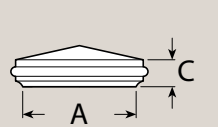
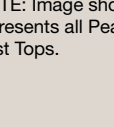

Installation Kit	Kit Contents
NPK10	Secures one 10" newel post to the structural substrate
NPK12	Secures one 12" newel post to the structural substrate
NPK13	Secures one 13" newel post to the structural substrate
NPK400	Secures one 6" newel post to the structural substrate
NPK600	Secures one 8" newel post to the structural substrate

# Post Accessories

	Part Number	Balustrade System	Bottom Width (A)	Top Width (B)	Height (C)	Accessories	
	B5X7 Ball Top	5", 7"	4 3/8"	5 1/4"	6 3/4"	PST7X7F	
	B10X13 Ball Top	12"	8 7/16"	10"	12 7/8"	PST13X13F PST14X14F	
	PST3X5 Pedestal Ball Top	5", 7"	3 1/2"	3"	4 3/4"	PST7X7F	
	PST6X6FP Fancy Peaked Top	5"	5 1/32"	—	2 1/16"	NP6X48	
	PST8X8FP Fancy Peaked Top	7"	8 1/16"	9 3/8"	2 15/16"	NP8X48	
	PST9X9FP Fancy Peaked Top	7"	8 7/8"	10 3/8"	3"	NPCP8X48 NPS8X48	
NOTE: Image shown represents all Fancy Peaked Tops.	PST11X11FP Fancy Peaked Top	7"	13 5/32"	—	4 1/2"	NP10X48	
	PST13X13FP Fancy Peaked Top	12"	12 21/32"	—	4 19/32"	NP12X48 NPCP13X48 NPS13X48	
	PST7X7F Flat Post Top	5"	6 1/2"	4 1/2"	1 1/2"	NP6X48	
	PST10X10F Flat Post Top	7"	9 1/2"	6 1/4"	2"	NP8X48 NPCP8X48 NPS8X48	

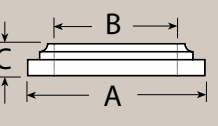
# Post Accessories

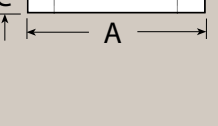
Continued

Part Number	Balustrade System	Bottom Width (A)	Top Width (B)	Height (C)	Accessories	
 PST13X13F Flat Post Top	12"	12 1/2"	8 21/32"	1 1/2"	B10X13 NP12X48	
 PST14X14F Flat Post Top	12"	14"	8 11/16"	3 1/8"	B10X13 NPCP13X48 NPSP13X48	
 PST12X12F Flat Post Top	7"	11 7/16"	10 1/2"	1 5/16"	NP10X48	
 PST7X7P Peaked Post Top	5"	6 1/2"	—	1 1/2"	NP6X48	
 PST10X10P Peaked Post Top	7"	9 1/2"	—	3"	NP8X48 NPCP8X48 NPSP8X48	
NOTE: Image shown represents all Peaked Post Tops.  PST13X13P Peaked Post Top	12"	13 1/2"	—	1 1/2"	NP12X48	
 PST14X14P Peaked Post Top	12"	14"	—	5"	NPCP13X48 NPSP13X48	
 TC6 Trim Collar	5"	9 1/8"	5 5/8"	2"	NP6X48	
 TC8 Trim Collar	7"	11 1/8"	7 5/8"	2"	NP8X48	
NOTE: Image shown represents all Trim Collars.  TC8-8 Trim Collar	7"	11 1/8"	8 1/8"	2"	NPCP8X48 NPSP8X48	



# Stone Euro Baluster

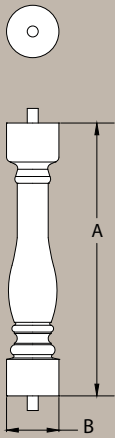

Part Number	Height (A)	Width (B)	Maximum Center-to-Center Distance
BAL5X28EUST	27 <sup>27</sup> / <sub>32</sub> "	5 <sup>11</sup> / <sub>32</sub> "	7 <sup>5</sup> / <sub>8</sub> "

# Stone Rails



	Part Number	Length	A	B	C	D	
 Top	BTR6X96ST	96"	23 <sup>13</sup> / <sub>16</sub> "	5 <sup>23</sup> / <sub>32</sub> "	4 <sup>31</sup> / <sub>32</sub> "	6 <sup>15</sup> / <sub>32</sub> "	
	BTR6X120ST <sup>^</sup>	120"	23 <sup>13</sup> / <sub>16</sub> "	5 <sup>23</sup> / <sub>32</sub> "	4 <sup>31</sup> / <sub>32</sub> "	6 <sup>15</sup> / <sub>32</sub> "	
 Bottom	BBR6X96ST	96"	23 <sup>13</sup> / <sub>16</sub> "	5 <sup>5</sup> / <sub>8</sub> "	4 <sup>27</sup> / <sub>32</sub> "	6 <sup>7</sup> / <sub>32</sub> "	
	BBR6X120ST <sup>^</sup>	120"	23 <sup>13</sup> / <sub>16</sub> "	5 <sup>5</sup> / <sub>8</sub> "	4 <sup>27</sup> / <sub>32</sub> "	6 <sup>7</sup> / <sub>32</sub> "	

<sup>^</sup> Maximum rail span distance for field applications is 96".

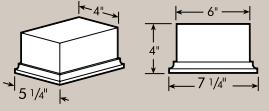

# Stone Installation Aids

Part Number	Installation Notes
 <p><b>RSB4X4X6<sup>^</sup></b> Rail Support Block</p>	<p>Install under the bottom rail at a span of 48" or less. Dimensions: 4" x 4" x 7 1/4" (may be trimmed for height)</p> 
<p><b>BRK6-7</b> Rail Installation Kit</p>	<p>Connects both ends of one 7" top or bottom rail to support structure. Order two kits per section.</p> <p><b>Kit Contents:</b> (2) Angle Brackets &amp; Mounting Hardware</p>

<sup>^</sup> Can be painted to blend with stone system.

## Stone Newel Post

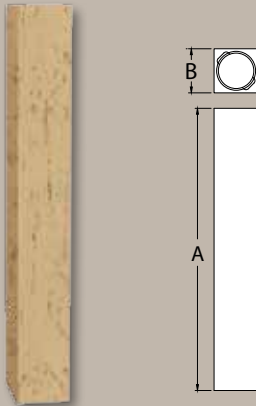

Part Number	A	B	Installation Kit	Accessories
NP8X48ST	48"	7 1/2"	NPK600	PST10X10PST

NOTE: Post tops shown are sold separately.

## Stone Post Accessories

Part Number	A	B
 <p><b>PST10X10PST</b></p>	9 1/2"	3"

