

Crown Mouldings	64
Crown Mouldings Dentil	69
Crown Mouldings Decorative	71
Cornice Mouldings	73
Smooth Flat Trim	76
Trim Brick Mould	77
Trim & Casing	78
Mouldings	78
Mouldings Dentil	87
Mouldings Decorative	90
Moulding Accessories	91
Miterless Accessories	92
Timber Flat Trim	92
Timber Brick Mould Stainable	93



FYPON[®]

Break the Mould Mouldings

Take the ordinary and make it magnificent with more than 100 architectural styles – from massive cornice mouldings and dentil profiles to delicate Florentine trim and chair rails. Whether you want a simple, elegant design or something more elaborate, Fypon's variety of styles, sizes and combinations allows you to create a look like no other. **For installation instructions, please visit www.fypon.com.**

Products shown: MLD600, CM13EA

How to Use This Section

The products in this section of the catalog are organized by architectural style. You can find a variety of products to match the aesthetics of almost any application conveniently grouped together. Where applicable, groups of mouldings are further sorted by height, from smallest to largest.

Crown Mouldings		
Part Number	Projection (A)	Height (B)
MLD593-16	2 1/2"	2 1/2"

How to Order Mouldings

First choose the product that best fits your application. The large variety of sizes and styles can be applied to any home. Mouldings can be used individually or combined to create a new and distinctive look.

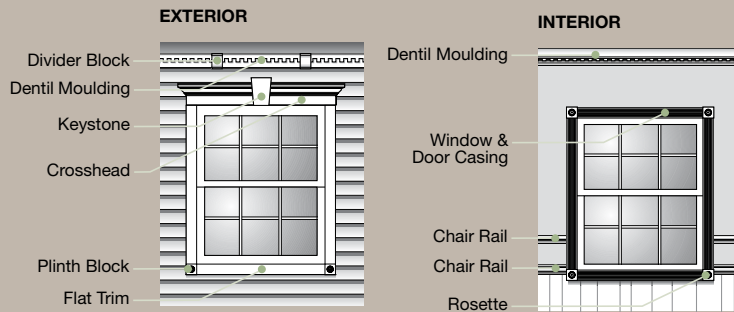

Table & Blade Angles

For recommended table and blade angles for mitering 90° corners, please visit www.fypon.com.

Remember to Order Adhesive

A urethane-based adhesive **must** be used on all joint surfaces. See page 190 to order Loctite® PL Premium® Adhesive.*

Moulding Accessories



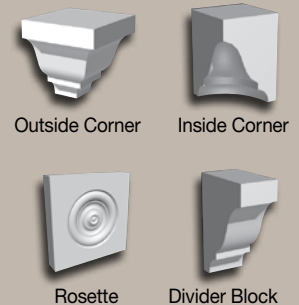







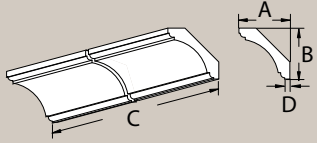

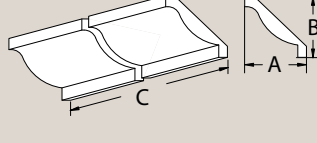

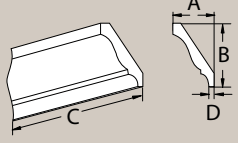

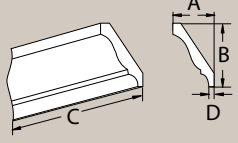

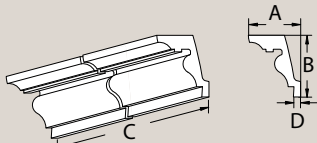

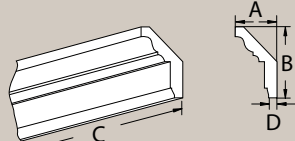
The accessories shown here are available to help make moulding installations quick and easy. Inside and outside corners eliminate the hassle of figuring complex miter cuts. Divider blocks and rosettes can be used between moulding lengths to eliminate the need for patching to create smooth seams. All moulding accessories are unattached and must be ordered separately. Refer to page 92 for miterless moulding accessories.

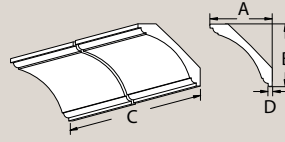

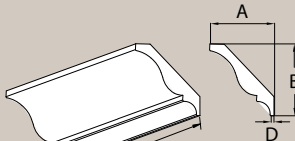
Custom Products

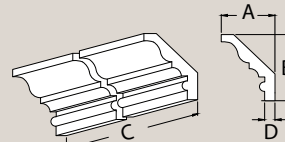

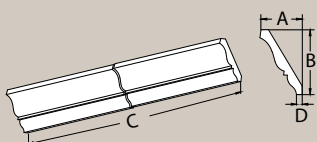

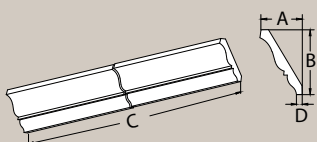





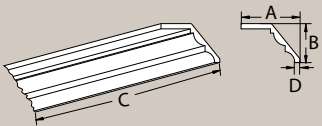

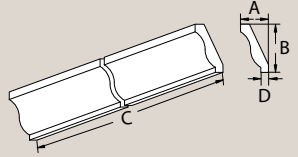

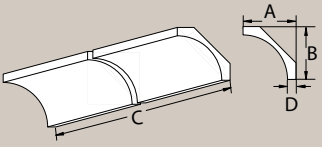

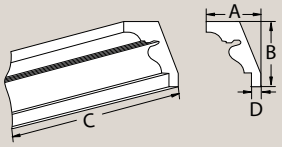
To request a unique custom product design, please contact the Fypon Custom Product Sales Department at 855.397.6647. You may also fill out our Quote Request Form, which can be obtained at www.fypon.com/products/custom.asp, or contact the Fypon Customer Service Department at 800.446.3040.

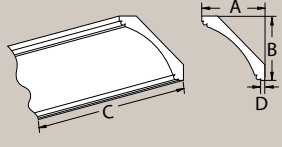
Crown Mouldings

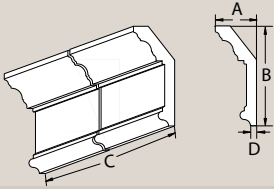
	Part Number	Projection (A)	Height (B)	Length (C)	Bottom Thickness (D)	
	MLD593-16	2 1/2"	2 1/2"	16'	1/4"	
	MLD451-16	3 1/8"	3"	16'	1/2"	
	MLD452-8	2"	3"	8'	1/4"	
	MLD452-12	2"	3"	12'	1/4"	
	MLD462-16	2 3/4"	3 1/4"	16'	5/16"	
	MLD552-12 Classic Crown Fascia	2 1/8"	3 1/2"	12'	3/8"	
	MLD592-16	3 3/4"	3 7/8"	16'	1/4"	
	MLD454-12	3 19/32"	4 1/32"	12'	7/32"	
	MLD572-16	3 1/4"	4 3/16"	16'	5/8"	
	MLD456-12	2 3/4"	4 3/8"	12'	5/16"	
	MLD456-16	2 3/4"	4 3/8"	16'	5/16"	

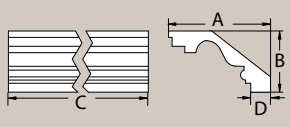
Crown Mouldings

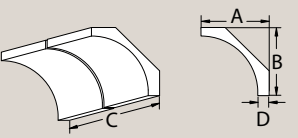

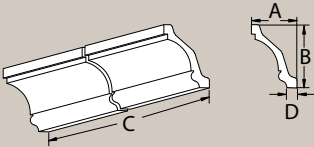







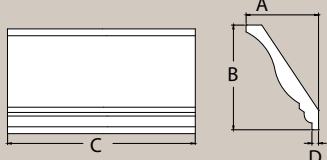

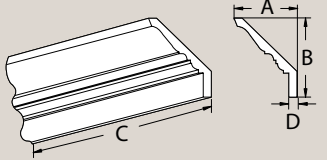

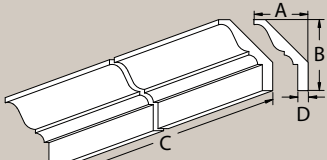

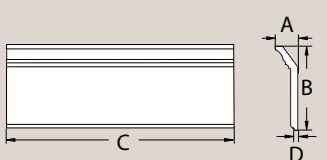
Continued

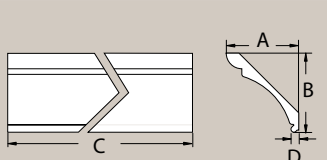
	Part Number	Projection (A)	Height (B)	Length (C)	Bottom Thickness (D)	
	MLD471-12	7 1/8"	4 5/8"	12'	5/8"	
	MLD467-16	2 3/4"	4 3/4"	16'	3/4"	
	MLD584-16	4 3/4"	4 3/4"	16'	3/4"	
	MLD460-12	4 3/8"	5 1/8"	12'	3/4"	
	MLD606-12	5 1/4"	5 1/4"	12'	5/16"	
	MLD587-16	2 3/8"	5 3/4"	16'	11/32"	
	MLD470-12	10"	6"	12'	1 15/16"	
	MLD590-16	6"	6 1/4"	16'	1"	
	MLD589-16	4 3/8"	6 1/2"	16'	1 1/8"	

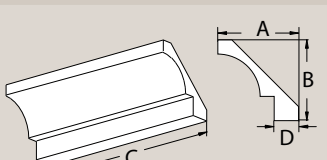

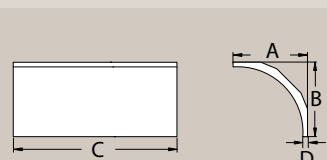

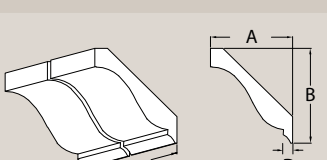

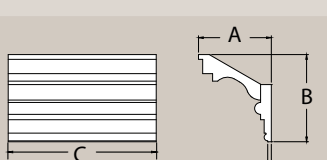





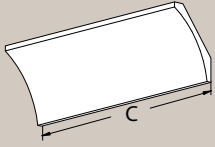
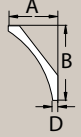

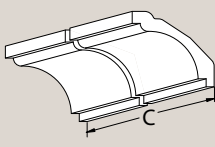
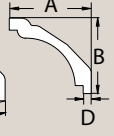

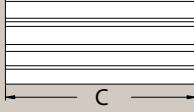
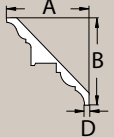

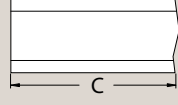
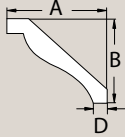
Crown Mouldings

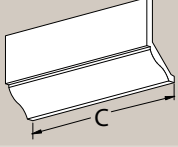
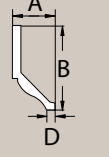
Continued

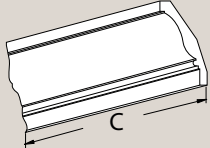
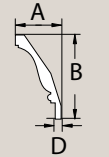
	Part Number	Projection (A)	Height (B)	Length (C)	Bottom Thickness (D)		
	MLD453-16	4 11/16"	6 11/16"	16'	7/16"		
	MLD570-12 E-Vent Match EV570	5 1/2"	6 7/8"	12'	3/4"		
	MLD569-12	5 13/16"	7 17/32"	12'	1 3/32"		
	MLD253-16	2 3/8"	7 5/8"	16'	3/8"		
	MLD457-12	6 7/8"	7 5/8"	12'	3/4"		
	MLD582-12	7 7/8"	7 7/8"	12'	2 3/8"		
	MLD583-16	8"	8"	16'	1/2"		
	MLD449-16	7 1/4"	8 1/2"	16'	5/32"		
	MLD480-12 Ships in 2 pieces	7 7/8"	8 7/8"	12'	3/8"		

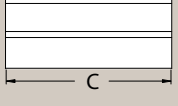
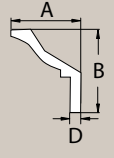
Crown Mouldings

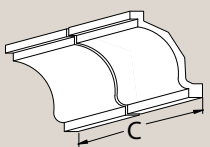
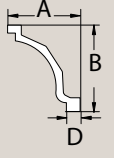

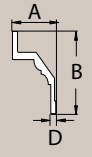







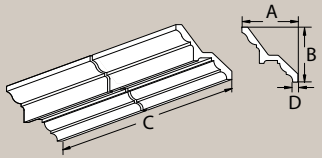

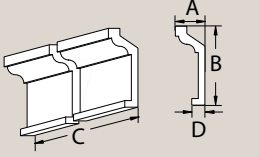

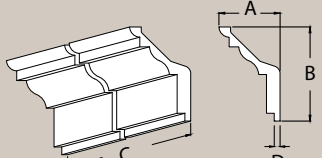
Continued

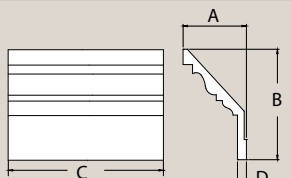
	Part Number	Projection (A)	Height (B)	Length (C)	Bottom Thickness (D)		
	MLD635-12	6"	9"	12'	5/8"		
	MLD591-16	10 1/4"	9 7/16"	16'	1"		
	MLD535-16	9"	9 1/2"	16'	1/2"		
	MLD450-16	11 7/16"	9 5/8"	16'	1 9/16"		
	MLD581-12	5"	9 15/16"	12'	1"		
	MLD555-12	5 3/16"	10 11/16"	12'	7/8"		
	MLD371-16	6 1/2"	11"	16'	1"		
	MLD588-16	9 1/4"	11"	16'	1 3/4"		
	MLD364-12	8 11/16"	11 5/16"	12'	1"		

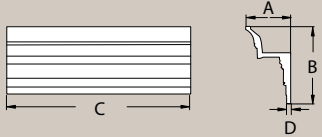

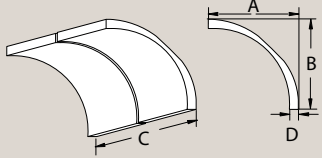
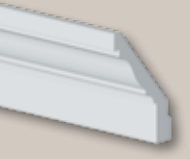
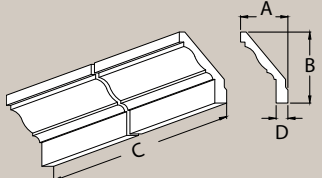
Crown Mouldings

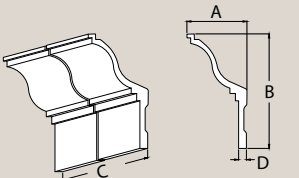
Continued

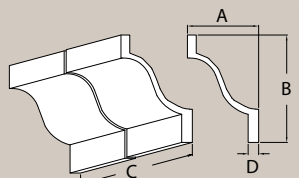
	Part Number	Projection (A)	Height (B)	Length (C)	Bottom Thickness (D)	
	MLD642-12	12"	11 3/4"	12'	1 3/8"	
	MLD539-16	4 1/2"	12"	16'	2"	
	MLD524-16	8"	12 1/8"	16'	1"	
	MLD580-12 E-Vent Match EV580	7 1/8"	12 3/8"	12'	1"	
	MLD372-14	8 1/4"	13 7/8"	14'	3/4"	
	MLD734-12	14 3/8"	14 3/8"	12'	1 9/32"	
	MLD556-16	10"	15"	16'	2 1/2"	
	MLD536-12	8 1/8"	15 1/2"	12'	1"	
	MLD528-12	9 7/16"	15 11/16"	12'	1 1/2"	





Crown Mouldings

Continued

Part Number	Projection (A)	Height (B)	Length (C)	Bottom Thickness (D)	
 MLD586-16	7"	16 1/2"	16'	1"	
 MLD585-12	10 1/2"	17"	12'	7/8"	
 MLD481-12	14 13/16"	17 3/8"	12'	1 11/16"	

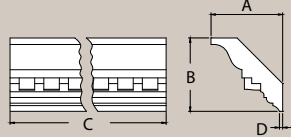









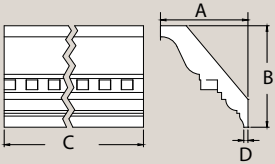

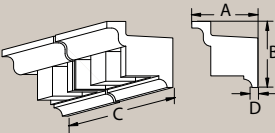

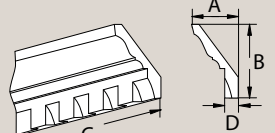

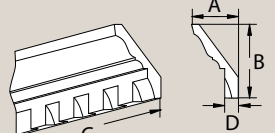
Crown Mouldings

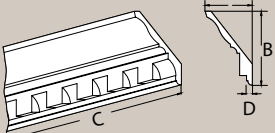
Dentil

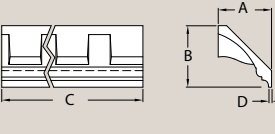
Part Number	Projection (A)	Height (B)	Length (C)	Bottom Thickness (D)	Design Repeat	Tooth & Space
 MLD400-8	2 15/16"	2 11/16"	8'	1/8"	1"	5/8" Tooth 3/8" Space 
 MLD404-8	2 1/2"	3 7/8"	8'	1/4"	1 1/2"	3/4" Tooth
 MLD404-12	2 1/2"	3 7/8"	12'	1/4"	1 1/2"	3/4" Tooth
 MLD404-16	2 1/2"	3 7/8"	16'	1/4"	1 1/2"	3/4" Space
 MLD406-16	3 3/8"	4"	16'	3/8"	2"	1 1/4" Tooth 3/4" Space 

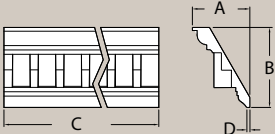

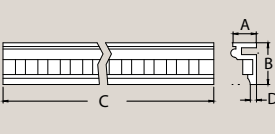
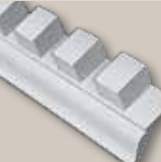
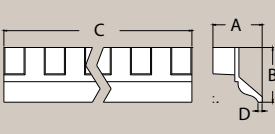
Crown Mouldings

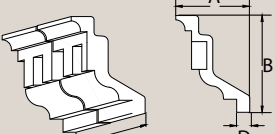
Dentil continued

	Part Number	Projection (A)	Height (B)	Length (C)	Bottom Thickness (D)	Design Repeat	Tooth & Space
	MLD432-12 Divider Block Accessory MDB432	3 15/16"	4 9/16"	12' 3"	3/16"	1"	1/2" Tooth 1/2" Space 
	MLD365-16	4 15/16"	5"	16'	3/8"	4 5/8"	2 1/4" Tooth 2 3/8" Space 
	MLD410-8	3 1/4"	6 7/8"	8'	7/16"	3"	1 1/2" Tooth 
	MLD410-12	3 1/4"	6 7/8"	12'	7/16"	3"	1 1/2" Space 
	MLD411-16	4 1/2"	7"	16'	1/2"	3"	1 1/2" Tooth 1 1/2" Space 
	MLD440-12	6 1/2"	7 1/4"	12'	3/8"	6 5/8"	4" Tooth 2 5/8" Space 
	MLD430-12	5 3/4"	8"	12' 2 1/4"	3/8"	2 5/8"	1 3/4" Tooth 7/8" Space 
	MLD362-16	5 5/32"	8 3/8"	16'	1 1/4"	4 1/2"	2 1/2" Tooth 2" Space 
	MLD435-16	9"	10"	16'	3/4"	7 3/8"	3 7/8" Tooth 3 1/2" Space 
	MLD413-12	8 1/2"	11 1/8"	12'	1 15/32"	5 5/8"	3" Tooth 2 5/8" Space 

Crown Mouldings

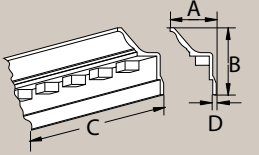
Dentil continued

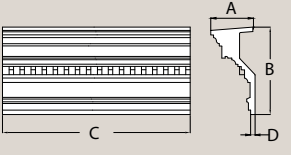
Part Number	Projection (A)	Height (B)	Length (C)	Bottom Thickness (D)	Design Repeat	Tooth & Space
 MLD421-12	10"	14 1/2"	12'	3/4"	6"	2" Tooth 4" Space 
 MLD461-8	9 13/16"	19"	8'	1"	2 1/2"	1 1/2" Tooth 1" Space 











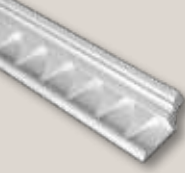
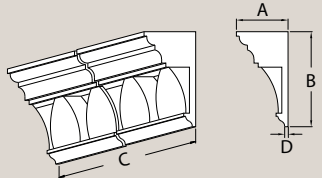

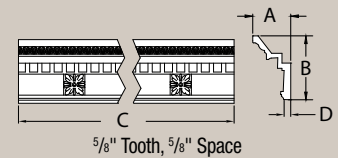

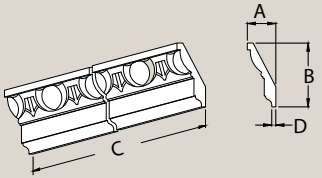
Crown Mouldings

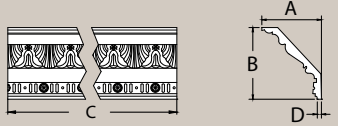
Decorative

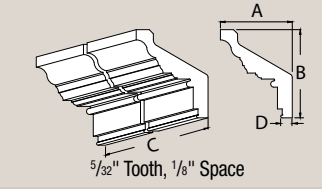
Part Number	Projection (A)	Height (B)	Length (C)	Bottom Thickness (D)	Design Repeat	Diagram
 MLD565-16 Egg & Dart	2 1/8"	3 1/2"	16'	3/16"	1"	
 MLD423-12	2 13/16"	5"	12'	7/16"	6 1/4"	
 MLD490-12 Florentine	6"	5 7/16"	11' 5"	1/4"	—	
 MLD491-12 Acanthus Leaf	6 1/4"	5 7/16"	12'	1/4"	4"	
 MLD608-12	4 3/4"	5 7/16"	12'	5/16"	—	

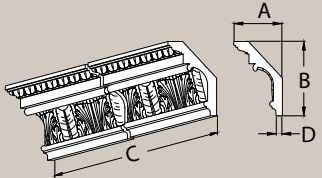

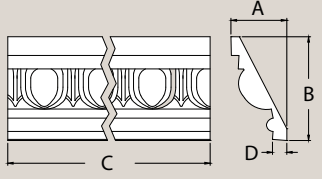
Crown Mouldings

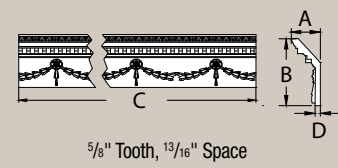
Decorative continued

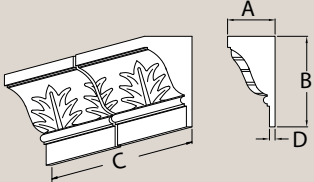

	Part Number	Projection (A)	Height (B)	Length (C)	Bottom Thickness (D)	Design Repeat	
	MLD651-16 Deco	2 7/8"	5 1/2"	16'	3/16"	5 15/32"	
	MLD405-12	3 5/8"	5 3/4"	12' 6"	5/8"	12 1/2"	
	MLD564-16 Egg & Dart	2 5/8"	5 7/8"	16'	1/4"	2 13/16"	
	MLD493-12 Crown Leaf Divider Block Accessory MDB493	5 17/32"	6 21/32"	12'	3/8"	4"	
	MLD436-16	5 1/2"	6 3/4"	16'	1/2"	9/32"	
	MLD732-12	4 3/4"	7 1/4"	12'	5/8"	5 3/8"	
	MLD560-8 Egg & Dart	5 25/32"	9 5/32"	8'	1 3/8"	5 7/16"	
	MLD425-12	4 1/8"	9 1/2"	11' 5"	3/4"	13 1/2"	

Crown Mouldings

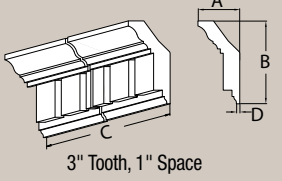
Decorative continued











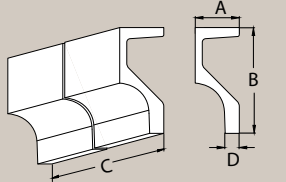

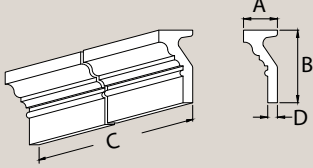

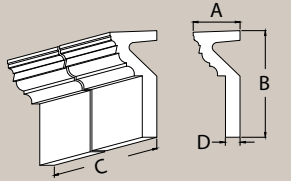
	Part Number	Projection (A)	Height (B)	Length (C)	Bottom Thickness (D)	Design Repeat	
	MLD495-16	5 3/8"	10 1/16"	16'	5/8"	7 3/4"	
	MLD412-16	5 3/8"	10 21/32"	16'	7/16"	4"	

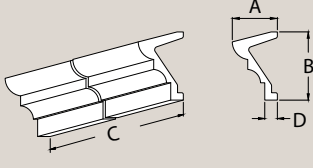
Cornice Mouldings

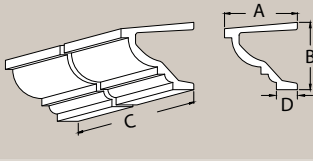
	Part Number	Projection (A)	Height (B)	Length (C)	Bottom Thickness (D)	Design Repeat	
	MLD513-16	4 1/8"	4 3/8"	16'	3/4"	—	
	MLD523-16	2"	5 1/4"	16'	1/2"	—	
	MLD509-16	3 1/4"	5 3/8"	16'	1 3/4"	—	
	MLD510-12	4 3/8"	5 1/2"	12'	5/8"	—	
	MLD511-12	5 3/4"	6 9/16"	12'	3/4"	—	

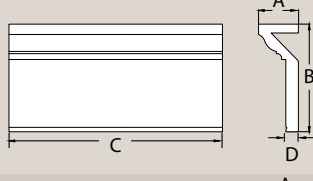

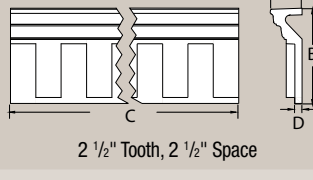

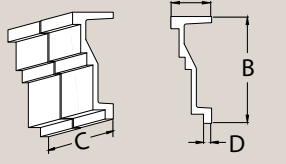

Cornice Mouldings

Continued

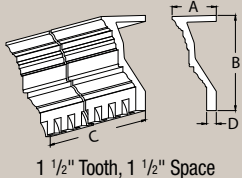
	Part Number	Projection (A)	Height (B)	Length (C)	Bottom Thickness (D)	Design Repeat		
	MLD548-16	3 1/8"	7 1/2"	16'	1 1/8"	—		
	MLD527-16	3 1/2"	7 5/8"	16'	1"	—		
	MLD508-12	3 5/8"	8 3/8"	12'	1 5/32"	—		
	MLD547-16	5 3/8"	8 5/8"	16'	1 1/2"	—		
	MLD545-12	10"	9 1/16"	12'	2 7/8"	—		
	MLD246-16	3 3/8"	9 1/8"	16'	1"	—		
	MLD336-16	3 1/8"	9 3/8"	16' 1"	1 1/16"	5"		2 1/2" Tooth, 2 1/2" Space
	MLD521-8 Sign Fascia	5"	13 1/8"	8'	15/16"	—		

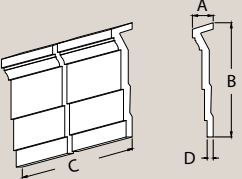
Cornice Mouldings

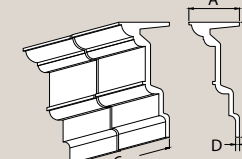
Continued

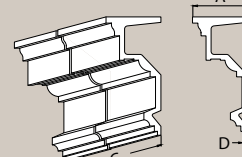
	Part Number	Projection (A)	Height (B)	Length (C)	Bottom Thickness (D)	Design Repeat	
	MLD419-12	6 3/4"	14 1/2"	12'	1 3/8"	3"	 1 1/2" Tooth, 1 1/2" Space
	MLD506-16	3"	16 3/8"	16'	7/8"	—	
	MLD533-12	5 1/2"	17"	12'	2 1/2"	—	
	MLD543-12	8 1/4"	19"	12'	1/2"	—	
	MLD534-12	8 7/8"	19 1/8"	12'	9/16"	—	



Smooth Flat Trim



Part Number	Thickness (A)	Width (B)	Length (C)	Accessories
FLT177-8	1/2"	1"	8'	—
FLT131-16	1/2"	3"	16'	—
FLT178-8	1/2"	14"	8'	—
FLT100-12	5/8"	4 3/4"	12'	—
FLT181-8	5/8"	24"	8'	—
FLT101-12	3/4"	1 1/2"	12'	—
FLT102-8	3/4"	2 1/8"	8'	—
FLT102-10	3/4"	2 1/8"	10'	—
FLT103-12	3/4"	3"	12'	PB3X3, PB4X4
FLT122-16	3/4"	3 1/2"	16'	—
FLT110-16	3/4"	5 1/2"	16'	—
FLT109-12	3/4"	6"	12'	—
FLT186-16	3/4"	7 1/4"	16'	—
FLT113-8	3/4"	8"	8'	—
FLT118-8	3/4"	10"	8'	—
FLT152-8	1"	3 1/2"	8'	4F Arches
FLT152-12	1"	3 1/2"	12'	4F Arches
FLT152-16	1"	3 1/2"	16'	4F Arches
FLT153-12	1"	4"	12'	—
FLT159-8	1"	5 1/2"	8'	6F Arches, PB6X6
FLT159-12	1"	5 1/2"	12'	6F Arches, PB6X6
FLT159-16	1"	5 1/2"	16'	6F Arches, PB6X6
FLT162-6	1"	7 1/2"	6'	PB7X7, K8TF
FLT162-8	1"	7 1/2"	8'	PB7X7, K8TF
FLT162-14	1"	7 1/2"	14'	PB7X7, K8TF
FLT170-12	1"	9 1/2"	12'	—
FLT170-16	1"	9 1/2"	16'	—

Smooth Flat Trim

Continued

Part Number	Thickness (A)	Width (B)	Length (C)	Accessories
FLT172-16	1"	11 1/2"	16'	—
FLT175-12	1"	12"	12'	—
FLT179-12	1"	16"	12'	—
FLT180-12	1"	24"	12'	—
FLT119-17	1"	32 1/4"	16' 11"	—
FLT125-8	1"	36"	8'	—
FLT40X96	1"	40"	8'	—
FLT184-16	1 1/2"	1 1/2"	16'	—
FLT194-10	1 1/2"	3 1/2"	10'	—
FLT183-12	1 1/2"	5 1/2"	12'	—
FLT163-16	1 1/2"	7 1/2"	16'	—
FLT182-12	1 1/2"	12 1/4"	12'	—
FLT185-12	1 1/2"	16 1/2"	12'	—
FLT190-12	2"	4"	12'	—

Trim

Brick Mould

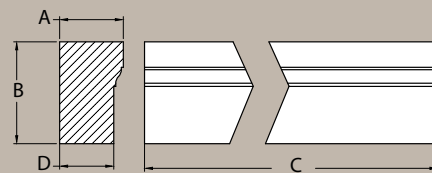





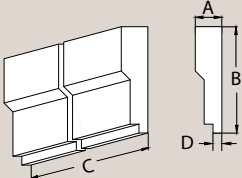



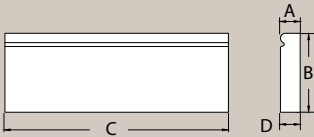

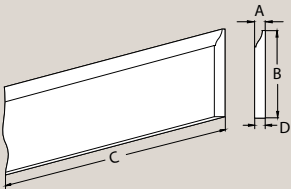

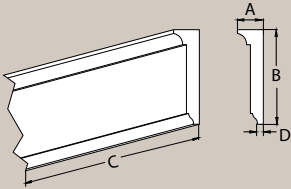

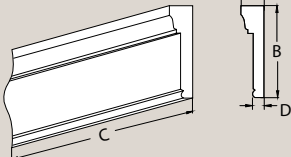



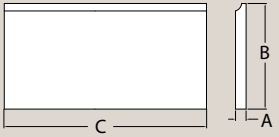

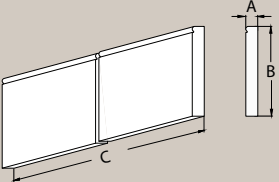

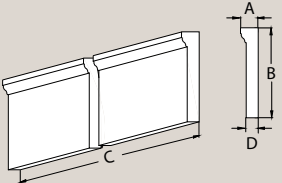
Part Number	Projection (A)	Height (B)	Length (C)	Bottom Thickness (D)	Accessories
MLDWM180-8	1 1/4"	2"	8'	1 1/16"	 Keystone KWM180M Page 43
MLDWM180-16	1 1/4"	2"	16'	1 1/16"	
MLDWM181-16	13/16"	2"	16'	5/8"	
MLDWM183-16	1 1/2"	2 1/8"	16'	1 5/16"	
MLDWM182-12	1 1/4"	3"	12'	1 1/16"	

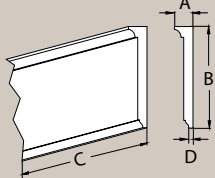
Trim & Casing

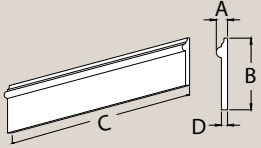
Part Number	Projection (A)	Height (B)	Length (C)	Bottom Thickness (D)	
 MLD637-16 Flat Astragal	9/16"	1 1/2"	16'	3/4"	
 MLD710-10 Sill	3 1/2"	1 1/2" Tapers to 1"	10'	—	
 MLD239-16	3/4"	3"	16'	3/4"	

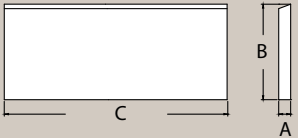

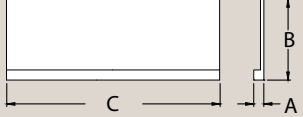

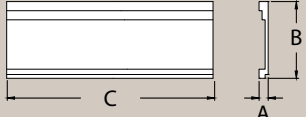





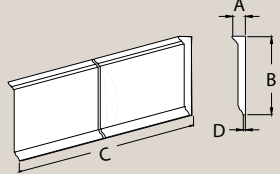

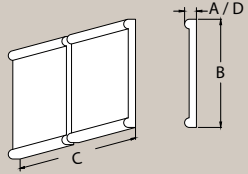

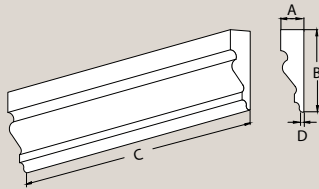

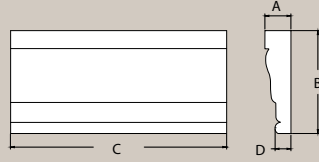
Mouldings

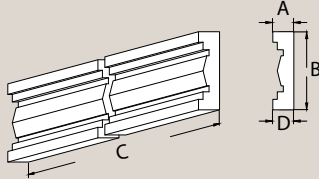
Part Number	Projection (A)	Height (B)	Length (C)	Bottom Thickness (D)	Accessories	
 MLD715-16 Beaded	1"	4"	16'	—	—	
NOTE: Line art is representative of actual part.						
 MLD706-16 Base Trim	5/8"	5 1/4"	16'	—	PB6X6	
 MLD224-12	1 1/2"	5 1/2"	12'	3/8"	—	
 MLD226-8	1 1/2"	5 1/2"	8'	3/4"	K226M PB220	
MLD226-10	1 1/2"	5 1/2"	10'	3/4"		
MLD226-12	1 1/2"	5 1/2"	12'	3/4"		
MLD226-16	1 1/2"	5 1/2"	16'	3/4"		

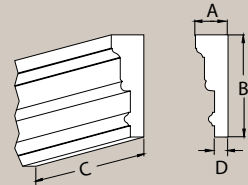
	Part Number	Projection (A)	Height (B)	Length (C)	Bottom Thickness (D)	Accessories	
	MLD705-16 Cove	3/4"	7 1/2"	16'	—	—	
	MLD735-16 Beaded	1"	7 1/2"	16'	—	—	
	MLD232-16	1 9/16"	7 7/8"	16'	1 1/16"	—	
	MLD225-12	1 1/2"	8 1/2"	12'	3/8"	—	
	MLD247-16	1 3/8"	8 11/16"	16'	3/4"	—	
	MLD708-12 Bevel	1 1/2"	12"	12'	—	—	
	MLD531-8 Matches MLD530-8	1 1/2"	12"	8'	—	—	
	MLD530-8 Matches MLD531-8	1 1/2"	12 5/8"	8'	—	—	

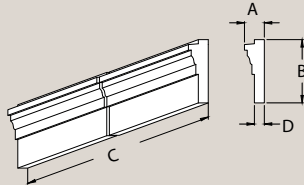

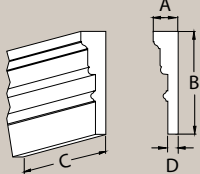







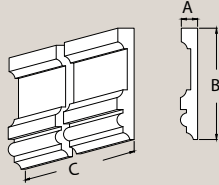

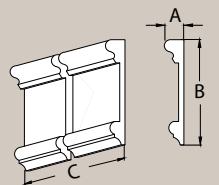

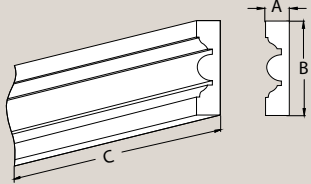
Mouldings

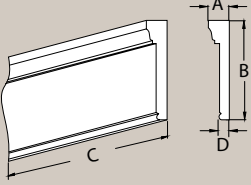
Continued

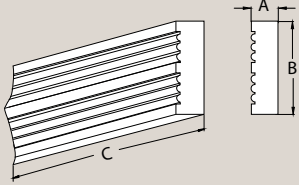
Part Number	Projection (A)	Height (B)	Length (C)	Bottom Thickness (D)	Accessories	
 MLD223-16	2 1/2"	14 1/2"	16'	7/16"	—	
 MLD522-16 Sign Fascia	1 5/8"	14 3/4"	16'	1 5/8"	—	
 MLD621-16	9/16"	2"	16'	1/8"	—	
 MLD230-16	13/16"	3 1/4"	16'	1/2"	—	
 MLD235-16	7/8"	3 1/4"	16'	7/8"	—	
 MLD220-12 6M Profile	1 3/4"	5 1/2"	12'	3/4"	PB220 K6TM KP6TM	
 MLD220-16 6M Profile	1 3/4"	5 1/2"	16'	3/4"		
 MLD228-16	2"	6 3/8"	16'	1"	—	
 MLD221-8	1 3/4"	7"	8'	3/4"	—	
 MLD221-16	1 3/4"	7"	16'	3/4"		

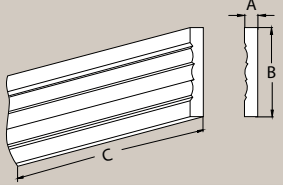

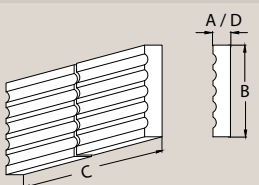

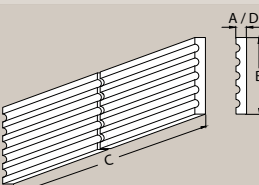





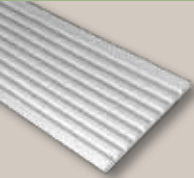
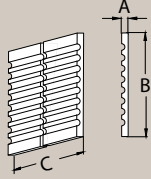

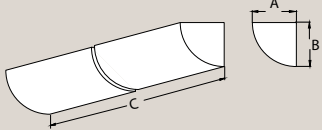

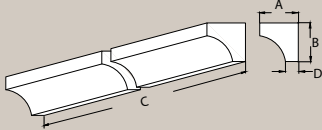
Mouldings

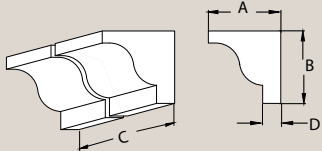
Continued

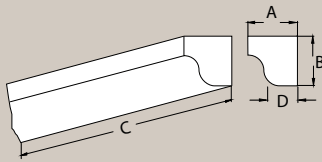
	Part Number	Projection (A)	Height (B)	Length (C)	Bottom Thickness (D)	Accessories	
	MLD541-16	1 1/4"	8 1/8"	16'	—	—	
	MLD538-16	1 5/8"	8 3/4"	16'	—	—	
	MLD245-12	1 15/16"	8 13/16"	12'	—	—	
	MLD227-16	1 1/2"	9"	16'	3/4"	—	
	MLD205-8	7/8"	3"	8'	—	PB3X3 PB4X4	
	MLD205-12	7/8"	3"	12'	—		
	MLD211-16	3/4"	5 1/8"	16'	—	PB5X5 PB5X5A PB6X6	
	MLD207-16 Fluted	1"	5 1/4"	16'	1"	PB6X6	
	MLD208-16 Fluted	1"	7 1/4"	16'	1"	PB7X7	

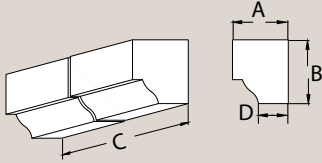
Mouldings

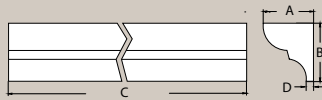
Continued

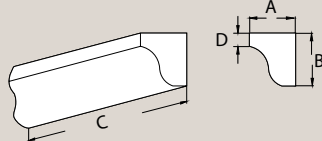
Part Number	Projection (A)	Height (B)	Length (C)	Bottom Thickness (D)	Accessories	
 MLD209-14 Fluted	1 1/2"	24"	14'	—	—	
 MLD603-8	1/2"	1/2"	8'	1/2"	—	
 MLD628-8 Cove	3/4"	3/4"	8'	1/4"	—	
 MLD633-8 Ogee	3/4"	3/4"	8'	3/16"	—	
 MLD602-8 Ogee Crosshead Trim Strip	13/16"	13/16"	8'	5/16"	—	
 MLD730-8	7/8"	1"	8'	5/16"	—	
 MLD626-8 Bed Moulding	1 1/32"	1 3/16"	8'	5/32"	—	
 MLD601-12 Ogee	1 5/16"	1 1/2"	12'	3/8"	—	

Mouldings











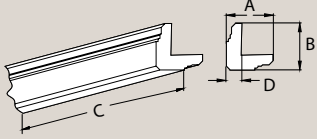

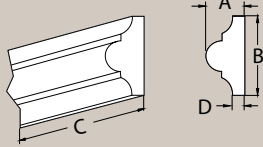
Continued

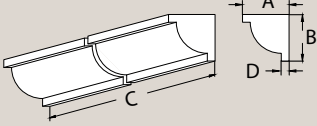
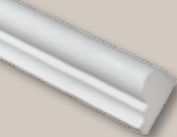
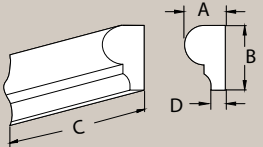

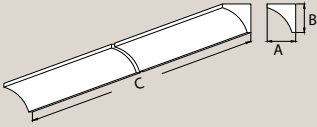

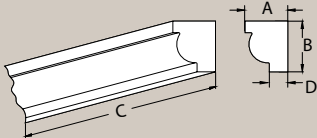

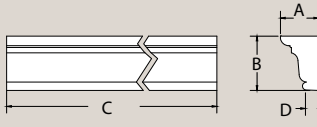

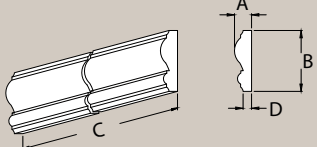

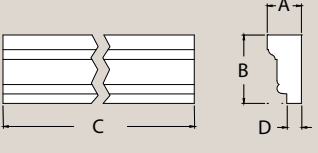

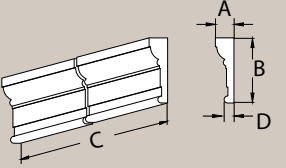
	Part Number	Projection (A)	Height (B)	Length (C)	Bottom Thickness (D)	Accessories		
	MLD612-12 Chair Rail	3/4"	1 3/8"	12'	1/8"	—		
	MLD455-12 Bed Moulding	1 1/4"	1 13/32"	12'	5/16"	—		
	MLD618-16 Base Cap	15/16"	1 1/2"	16'	15/16"	—		
	MLD648-16 Bed Moulding	1 1/2"	1 9/16"	16'	3/8"	—		
	MLD231-12 Window & Door Casing	1"	1 3/4"	12'	1/4"	—		
	MLD634-16 Ogee	1 3/8"	1 7/8"	16'	3/32"	—		
	MLD649-16 Bed Moulding	1 9/16"	2 1/16"	16'	11/32"	—		
	MLD627-12 Chair Rail	1 5/8"	2 1/8"	12'	9/16"	—		
	MLD627-16 Chair Rail	1 5/8"	2 1/8"	16'	9/16"	—		

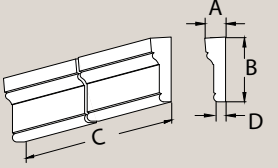

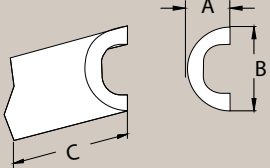
Mouldings

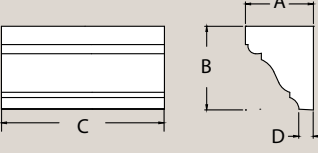
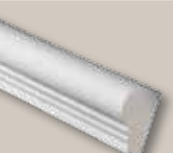

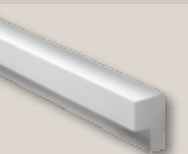
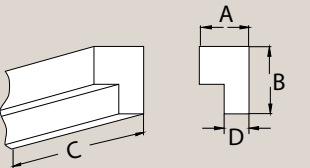

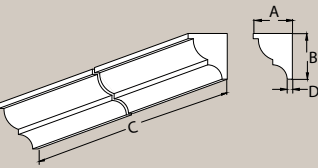





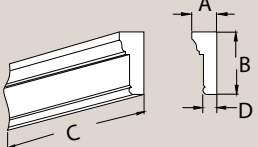



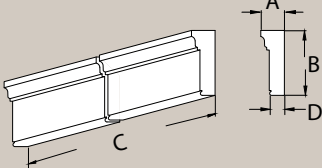

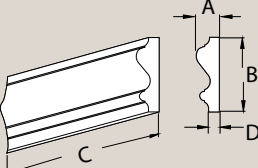
Continued

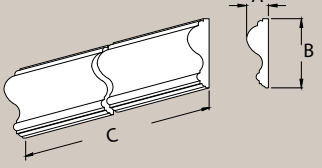
Part Number	Projection (A)	Height (B)	Length (C)	Bottom Thickness (D)	Accessories	
 MLD607-8 Corner Strip	2 1/4"	2 1/4"	8'	3/4"	—	
 MLD611-12 Chair Rail	1 1/8"	2 1/4"	12'	3/8"	—	
 MLD629-10 Bed Moulding	2 1/4"	2 1/4"	10'	3/8"	—	
 MLD610-8 Chair Rail	1 1/2"	2 3/8"	8'	1/2"	—	
 MLD660-10 Cove	2 3/8"	2 3/8"	10'	—	—	
 MLD613-12 Bed Moulding	2 3/8"	2 3/4"	12'	1"	—	
 MLD214-12 Window & Door Casing	2"	2 7/8"	12'	3/4"	—	
 MLD631-16 Chair Rail	7/8"	3"	16'	7/16"	—	

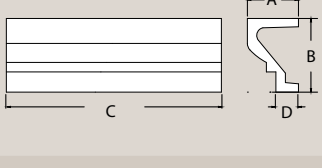
	Part Number	Projection (A)	Height (B)	Length (C)	Bottom Thickness (D)	Accessories		
	MLD215-12 4M Profile	1 3/4"	3 1/2"	12'	3/4"	PB215 K4TM KP4TM		
	MLD234-16 Window & Door Casing	1"	3 1/2"	16'	1 1/32"	—		
	MLD237-16	1 1/8"	3 1/2"	16'	1 3/32"	—		
	MLD605-12 Half Round	1 3/4"	3 1/2"	12'	—	—		
	NOTE: Line art is representative of actual part.							
	MLD240-8	3 1/4"	4"	8'	1 1/16"	DTLB6X4X6 DTLB9X11X16		
	MLD622-4 Chair Rail	2 13/16"	4"	4'	1 7/32"	—		
	MLD625-16 Chair Rail	3"	4"	16'	1 1/2"	—		
	MLD641-16	3 3/4"	4 3/8"	16'	1/2"	—		

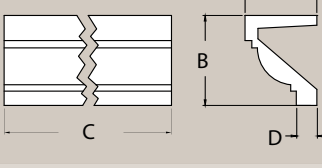
Mouldings

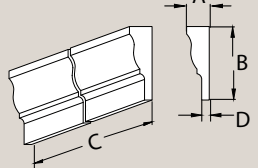
Continued

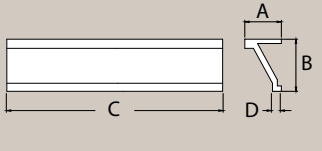
Part Number	Projection (A)	Height (B)	Length (C)	Bottom Thickness (D)	Accessories	
 MLD250-8	1 3/4"	4 1/2"	8'	1"		
 MLD250-10	1 3/4"	4 1/2"	10'	1"	DTLB6X4X6 DTLB9X11X16	
 MLD250-12	1 3/4"	4 1/2"	12'	1"		
 MLD236-16	2"	5 1/2"	16'	1 1/4"	PB220	
 MLD614-16 Chair Rail	1 5/8"	5 1/2"	16'	3/4"	—	
 MLD639-16 Fascia - Surround	1 7/8"	6 1/4"	16'	—	—	
 MLD311-16	5 3/8"	7 3/4"	16'	2 3/8"	—	
 MLD520-16	6 7/16"	8 1/16"	16'	1 7/8"	—	
 MLD644-16	3"	9 3/4"	16'	1"	—	
 MLD512-16	8 1/2"	12 1/8"	16'	2 1/16"	—	

NOTE: Line art is representative of actual part.

Mouldings

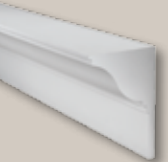

Continued

Part Number	Projection (A)	Height (B)	Length (C)	Bottom Thickness (D)	Accessories
 MLD505-8 Massive Fascia	3 3/8"	13"	8'	15/16"	—
 MLD472-12	11 1/4"	15 1/2"	12'	1 1/16"	—

NOTE: Line art is representative of actual part.

Mouldings

Dentil

Part Number	Projection (A)	Height (B)	Length (C)	Bottom Thickness (D)	Design Repeat	Tooth & Space	Accessories
 MLD303-5	5/8"	1 1/4"	5'	3/16"	1 1/2"	3/4" Tooth 3/4" Space	—
 MLD304-5	5/8"	1 1/4"	5'	3/16"	2 1/2"	1 1/4" Tooth	—
 MLD304-8	5/8"	1 1/4"	8'	3/16"	2 1/2"	1 1/4" Space	—
 MLD356-12	1 3/8"	1 7/8"	12'	—	2 3/8"	1 1/4" Tooth 1 1/8" Space	—
 MLD313-8	2 1/4"	2 3/8"	8'	1/4"	2"	1" Tooth 1" Space	—
 MLD355-8	5/8"	2 1/2"	8' 3/8"	—	2 1/8"	1 3/8" Tooth 3/4" Space	—

Mouldings

Dentil continued

Part Number	Projection (A)	Height (B)	Length (C)	Bottom Thickness (D)	Design Repeat	Tooth & Space	Accessories
 MLD354-12	1"	3 1/16"	12' 2 1/4"	—	3 1/4"	1 5/8" Tooth 1 5/8" Space	— 
 MLD351-8	1 1/4"	3 1/4"	8' 2"	—	7"	3 1/2" Tooth 3 1/2" Space	— 
 MLD350-8	7/8"	3 1/2"	8' 3 3/4"	1/2"	3 11/16"	2 3/16" Tooth 1 1/2" Space	— 
 MLD352-8	2"	3 1/2"	8' 3 3/4"	—	3 11/16"	2 3/16" Tooth 1 1/2" Space	— 
 MLD360-8	3 1/2"	3 3/4"	8'	—	8"	3 11/16" Tooth 4 5/16" Space	— 
 MLD353-8	1 1/4"	4 7/16"	8' 1/4"	—	8 3/4"	4 3/8" Tooth 4 3/8" Space	— 
 MLD310-8	1 1/4"	4 1/2"	8'	7/16"	3"	1 17/32" Tooth	DTLB6X4X6 DTLB9X11X16 
MLD310-12	1 1/4"	4 1/2"	12'	7/16"		1 15/32" Space	
MLD310-16	1 1/4"	4 1/2"	16'	7/16"			
 MLD332-8	1 5/8"	5"	8'	7/8"	4"	2" Tooth 2" Space	DTLB9X11X16 

Mouldings











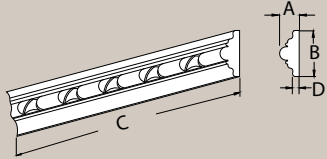

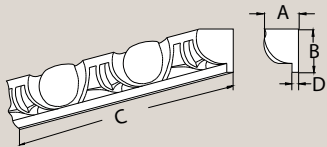
Dentil continued

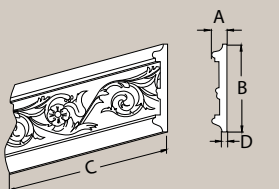
	Part Number	Projection (A)	Height (B)	Length (C)	Bottom Thickness (D)	Design Repeat	Tooth & Space	Accessories	
	MLD320-8	1 5/8"	5 3/4"	8'	3/8"		2 3/8" Tooth	—	
	MLD320-12	1 5/8"	5 3/4"	12'	3/8"	4 9/16"	2 3/16" Space	—	
	MLD320-16	1 5/8"	5 3/4"	16' 1 1/2"	3/8"				
	MLD335-12	3 3/8"	6 1/8"	12'	1/2"	7 1/4"	3 1/16" Tooth	—	
							4 3/16" Space		
	MLD330-12	1 5/8"	7"	12'	7/8"	4"	2" Tooth	—	
							2" Space		
	MLD370-8	6 1/2"	7 1/2"	8'	1"	19 1/4"	4 3/4" Tooth	—	
							14 1/2" Space		
	MLD331-16	1 3/8"	9 1/2"	16' 1 1/2"	3/4"	4 1/2"	2 1/4" Tooth	—	
							2 1/4" Space		
	MLD333-12	1 3/16"	11 1/2"	12' 4 1/2"	5/8"	5 1/2"	2 3/4" Tooth	—	
							2 3/4" Space		
	MLD334-12	4"	15"	12' 3"	2"	21"	9" Tooth	—	
							12" Space		
	MLD434-16	3 3/4"	16"	15' 9"	1/8"	21"	9" Tooth	—	
							12" Space		

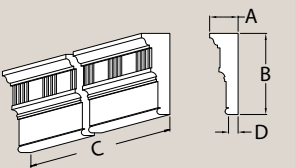
NOTE: Part comes with routed channel as shown in line art.

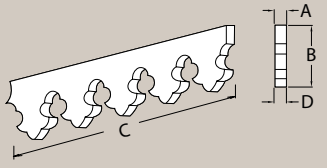

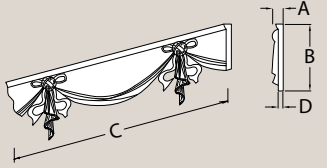
Mouldings

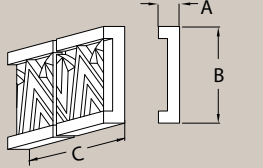
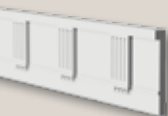
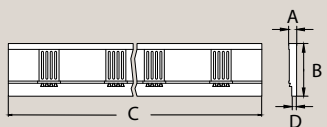
Decorative

	Part Number	Projection (A)	Height (B)	Length (C)	Bottom Thickness (D)	Design Repeat	
	MLD609-12 Chair Rail	7/8"	2 1/16"	12'	3/8"	1 7/8"	
	MLD562-8 Egg & Dart	2 3/8"	2 15/16"	8' 5"	7/16"	6 1/8"	
	MLD600-8 Florentine	3/4"	4 5/16"	8'	1/4"	5 5/8"	
	MLD600-10 Florentine	3/4"	4 5/16"	10'	1/4"	5 5/8"	
	MLD241-16	1 5/8"	4 3/4"	16'	17/32"	—	
	MLD640-8 Scalloped	1"	5 13/16"	8'	1"	6"	
	MLD604-12 Ribbon & Bow	1 5/16"	6 3/4"	11' 4"	5/8"	13 3/8"	
	MLD647-16 Deco	1 3/4"	8"	16'	1 3/4"	12"	
	MLD532-16	2"	13 1/2"	16'	1 1/4"	17 1/8"	



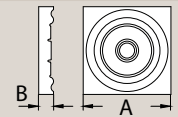
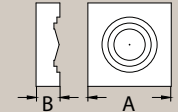
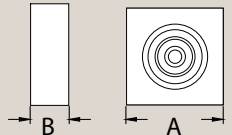
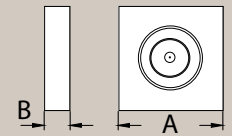

Moulding Accessories

Plinth Blocks / Rosettes

Part Number	Width (A)	Projection (B)	Matching Parts
NEW PB2.5X2.5	2 1/2"	3/4"	—
PB3X3	3 5/8"	7/8"	FLT103 MLD205
NEW PB3.5X3.5	3 1/2"	3/4"	—
 NEW PB3.875X3.875	3 7/8"	1 1/8"	—
PB4X4	3 5/8"	1 1/8"	FLT103 MLD205 4F Arches
PB5X5	5 1/4"	1"	FLT109 MLD211
PB6X6	5 5/8"	1 1/8"	FLT159 MLD211 MLD706 6F Arches
PB7X7	7 7/16"	1 3/16"	MLD208
 PB215	3 5/8"	1 1/8"	4M Arches MLD215
PB220	5 1/2"	2"	6M Arches, MLD220, MLD226, MLD236
 PB4X4X1	3 1/2"	1"	FLT103, MLD205, FLT122, MLD230, FLT152, 4F Arches
 PB5X5A	5 3/8"	1"	FLT109 MLD211



Miterless Accessories

Part Number	Height (A)	Width (B)	Moulding Match
 MIC1 Inside Corner	3 1/8"	2 1/8"	MLD452
 MOC1 Outside Corner	3 1/8"	2 25/32"	MLD452
 MDB432 Divider Block	4 11/16"	1 1/4"	MLD432
 MDB493 Divider Block	6 15/16"	3 1/8"	MLD493

Timber Flat Trim

Stainable

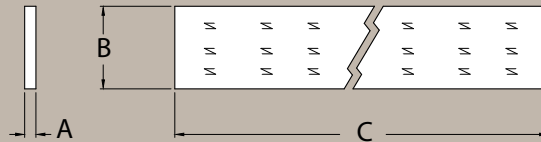

Part Number	Thickness (A)	Width (B)	Length (C)
FLT151-12S	3/4"	3 1/2"	12'
FLT110-12S	3/4"	5 1/2"	12'
FLT187-12S	3/4"	7 1/2"	12'
FLT173-12S	3/4"	11 1/2"	12'
FLT30X228X1S	1"	30"	19'
FLT150-12S	1 1/2"	3 1/2"	12'
FLT111-12S	1 1/2"	5 1/2"	12'
FLT197-12S	1 1/2"	7 1/2"	12'
FLT192-12S	1 1/2"	11 1/2"	12'

Timber Brick Mould

Stainable

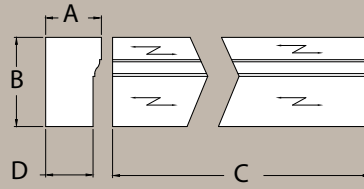

Part Number	Projection (A)	Height (B)	Length (C)	Bottom Thickness (D)
MLDWM180-8S	1 1/4"	2"	8'	1 1/16"

