

Crossheads	10
Pediments	24
Pilasters	32
Trim	37
Window Panels	42
Entrance Trim	44
Keystones	45
Shutters	46
Timber Shutters	49
Timber Pot Shelves	53
Timber Trim	55
Stone Pot Shelves	56
Stone Blocks	58
Stone Accessories	60

 The logo for FYPON, featuring the word "FYPON" in a bold, black, serif font. A blue wave-like graphic element is positioned above the letter "Y".

Make a Grand Entrance

Window & Door Trim

Transform an ordinary home into an extraordinary home with Fypon® window and door trim. Offering a wide range of styles and sizes, nothing can make a statement – and enhance nearly any architectural style – like window and door trim. Many pieces are designed to work together, and some can even be ordered moulded as one piece to further speed installation. From pilasters, pediments and crossheads to arches and panels, the options are virtually limitless – giving you the freedom to design a specialized look for your next project. **For installation instructions, please visit www.fypon.com.**

Products shown: PVC Flat Trim, MLD234-16

How to Use This Section

The products in this section of the catalog are organized by size, from smallest to largest. Where applicable, part numbers are shown for pre-fabricated products with attached accessories, and matching unattached accessories are referenced or shown with the product.



How to Order

Window Trim

To order window trim, first measure the window unit to be trimmed. Next choose the desired products and accessories to complete the look.

Door Trim & Entrance Systems

When ordering door trim, first measure the door unit to be trimmed. The unit can be measured with or without brick mould; however, the brick mould is essential when using a storm door. Next choose the desired pilaster style and size. Finally, choose a pediment or crosshead that is wide enough to span the opening plus the brick mould and pilasters (see example). Add desired accessories to complete the look.

Remember to Order Adhesive
 A urethane-based adhesive *must* be used on all joint surfaces. See page 190 to order Loctite® PL Premium® Adhesive.*

WINDOW TRIM TERMINOLOGY

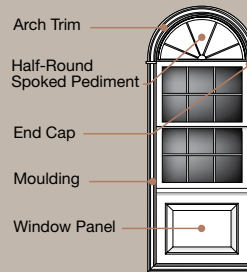

DOOR TRIM TERMINOLOGY

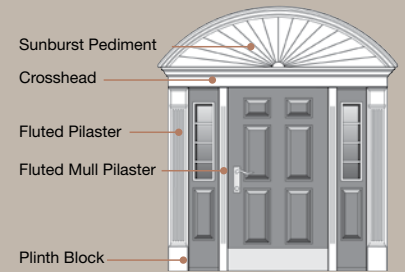

Window & Door Trim Accessories

Keystones, dentil trim, trim strip and bottom trim accessories are available attached to standard products as pre-fabricated products (see below). Keystones can also be ordered as unattached accessories by listing the line item on your order.

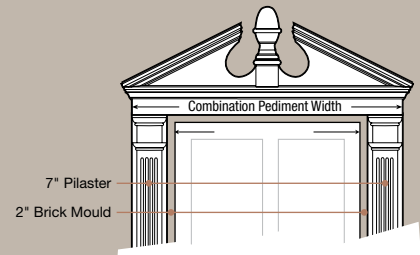

Window Crossheads with Attached Accessories

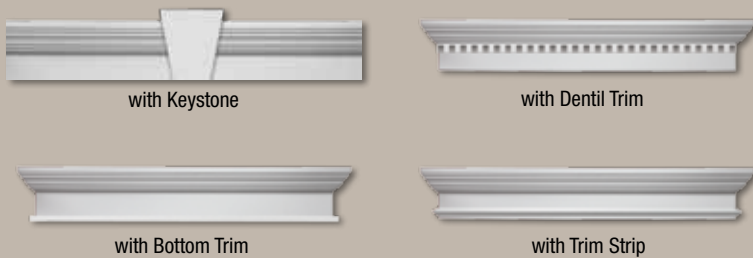

Without Accessories

With Accessories

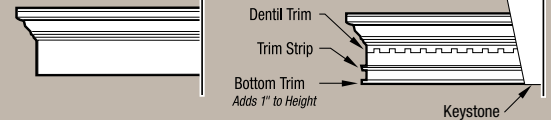

Keystone Options



Note: A keystone cannot be used when combining a crosshead with a pediment.

Pre-Fabricated & Custom Products

Throughout this section, pre-fabricated products with attached accessories are identified by an asterisk (*). To order a pre-fabricated product shown in this catalog, place your order using the part number shown. Additional pre-fabricated options may be available, including additional sizes and routing options. To request a pre-fabricated product not shown in this catalog – or to request a unique custom product design – please fill out our Quote Request Form, which can be obtained at www.fypon.com/products/custom.asp, or contact the Fypon Custom Product Sales Department at 855.397.6647 or the Fypon Customer Service Department at 800.446.3040.

* Loctite® PL Premium® is owned by Henkel Corporation.

6" Crosshead

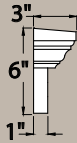

Standard

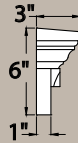
with Keystone
K6M[^]

with Dentil Trim



with Bottom Trim



with Trim Strip

Width	Overall Width	Part Number	Part Number w/ Keystone	Part Number w/ Dentil Trim	Part Number w/ Bottom Trim	Part Number w/ Trim Strip
24"	27 1/2"	WCH24X6	WCH24X6K*	WCH24X6D*	WCH24X7BT*	WCH24X6T*
28"	31 1/2"	WCH28X6	WCH28X6K*	WCH28X6D*	WCH28X7BT*	WCH28X6T*
30"	33 1/2"	WCH30X6	WCH30X6K*	WCH30X6D*	WCH30X7BT*	WCH30X6T*
31"	34 1/2"	WCH31X6	WCH31X6K*	WCH31X6D*	WCH31X7BT*	WCH31X6T*
32"	35 1/2"	WCH32X6	WCH32X6K*	WCH32X6D*	WCH32X7BT*	WCH32X6T*
33 5/8"	37 1/8"	WCH33X6	WCH33X6K*	WCH33X6D*	WCH33X7BT*	WCH33X6T*
34"	37 1/2"	WCH34X6	WCH34X6K*	WCH34X6D*	WCH34X7BT*	WCH34X6T*
35"	38 1/2"	WCH35X6	WCH35X6K*	WCH35X6D*	WCH35X7BT*	WCH35X6T*
36"	39 1/2"	WCH36X6	WCH36X6K	WCH36X6D*	WCH36X7BT	WCH36X6T*
37 5/8"	41 1/8"	WCH37X6	WCH37X6K	WCH37X6D*	WCH37X7BT*	WCH37X6T*
38"	41 1/2"	WCH38X6	WCH38X6K*	WCH38X6D*	WCH38X7BT*	WCH38X6T*
40"	43 1/2"	WCH40X6	WCH40X6K	WCH40X6D	WCH40X7BT	WCH40X6T*
41 5/8"	45 1/8"	WCH41X6	WCH41X6K*	WCH41X6D*	WCH41X7BT*	WCH41X6T*
43"	46 1/2"	WCH43X6	WCH43X6K*	WCH43X6D*	WCH43X7BT	WCH43X6T*
44"	47 1/2"	WCH44X6	WCH44X6K	WCH44X6D*	WCH44X7BT	WCH44X6T*
46"	49 1/2"	WCH46X6	WCH46X6K*	WCH46X6D*	WCH46X7BT	WCH46X6T*
47"	50 1/2"	WCH47X6	WCH47X6K*	WCH47X6D*	WCH47X7BT*	WCH47X6T*
48"	51 1/2"	WCH48X6	WCH48X6K	WCH48X6D*	WCH48X7BT*	WCH48X6T*
50"	53 1/2"	WCH50X6	WCH50X6K*	WCH50X6D*	WCH50X7BT*	WCH50X6T*
51"	54 1/2"	WCH51X6	WCH51X6K*	WCH51X6D*	WCH51X7BT*	WCH51X6T*
52"	55 1/2"	WCH52X6	WCH52X6K*	WCH52X6D*	WCH52X7BT*	WCH52X6T*
54"	57 1/2"	WCH54X6	WCH54X6K*	WCH54X6D*	WCH54X7BT*	WCH54X6T*
56"	59 1/2"	WCH56X6	WCH56X6K*	WCH56X6D*	WCH56X7BT*	WCH56X6T*
60"	63 1/2"	WCH60X6	WCH60X6K*	WCH60X6D*	WCH60X7BT*	WCH60X6T*
64"	67 1/2"	WCH64X6	WCH64X6K*	WCH64X6D*	WCH64X7BT	WCH64X6T*

* Pre-Fabricated Product

^ This part uses Keystone K6M. Refer to page 45 for more Keystone options.

6" Crosshead

Continued

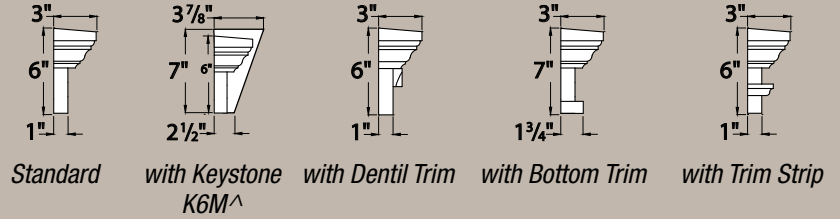

Width	Overall Width	Part Number	Part Number w/ Keystone	Part Number w/ Dentil Trim	Part Number w/ Bottom Trim	Part Number w/ Trim Strip
66"	69 1/2"	WCH66X6	WCH66X6K*	WCH66X6D*	WCH66X7BT*	WCH66X6T*
67"	70 1/2"	WCH67X6	WCH67X6K*	WCH67X6D*	WCH67X7BT*	WCH67X6T*
68"	71 1/2"	WCH68X6	WCH68X6K*	WCH68X6D*	WCH68X7BT*	WCH68X6T*
72"	75 1/2"	WCH72X6	WCH72X6K	WCH72X6D*	WCH72X7BT*	WCH72X6T*
73"	76 1/2"	WCH73X6	WCH73X6K*	WCH73X6D*	WCH73X7BT*	WCH73X6T*
74"	77 1/2"	WCH74X6	WCH74X6K*	WCH74X6D*	WCH74X7BT*	WCH74X6T*
76"	79 1/2"	WCH76X6	WCH76X6K*	WCH76X6D*	WCH76X7BT*	WCH76X6T*
78"	81 1/2"	WCH78X6	WCH78X6K*	WCH78X6D*	WCH78X7BT*	WCH78X6T*
79"	82 1/2"	WCH79X6	WCH79X6K*	WCH79X6D*	WCH79X7BT*	WCH79X6T*
80"	83 1/2"	WCH80X6	WCH80X6K	WCH80X6D*	WCH80X7BT	WCH80X6T*
80 1/2"	84"	WCH80.5X6	WCH80.5X6K*	WCH80.5X6D*	WCH80.5X7BT*	WCH80.5X6T*
84"	87 1/2"	WCH84X6	WCH84X6K*	WCH84X6D*	WCH84X7BT*	WCH84X6T*
86"	89 1/2"	WCH86X6	WCH86X6K*	WCH86X6D*	WCH86X7BT*	WCH86X6T*
87"	90 1/2"	WCH87X6	WCH87X6K*	WCH87X6D*	WCH87X7BT*	WCH87X6T*
96"	99 1/2"	WCH96X6	WCH96X6K*	WCH96X6D*	WCH96X7BT*	WCH96X6T*
100"	103 1/2"	WCH100X6	WCH100X6K*	WCH100X6D*	WCH100X7BT*	WCH100X6T*
103"	106 1/2"	WCH103X6	WCH103X6K*	WCH103X6D*	WCH103X7BT*	WCH103X6T*
104"	107 1/2"	WCH104X6	WCH104X6K*	WCH104X6D*	WCH104X7BT*	WCH104X6T*
108"	111 1/2"	WCH108X6	WCH108X6K*	WCH108X6D*	WCH108X7BT*	WCH108X6T*
110"	113 1/2"	WCH110X6	WCH110X6K*	WCH110X6D*	WCH110X7BT	WCH110X6T*
144"	147 1/2"	WCH144X6	WCH144X6K*	WCH144X6D*	WCH144X7BT*	WCH144X6T*

* Pre-Fabricated Product

^ This part uses Keystone K6M. Refer to page 45 for more Keystone options.

9" Narrow Crosshead

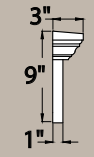

Standard

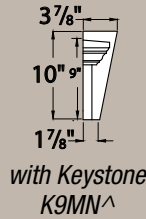

with Keystone
K9MN[^]



with Dentil Trim

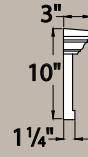

with Bottom Trim

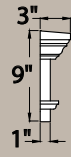

with Trim Strip

Width	Overall Width	Part Number	Part Number w/ Keystone	Part Number w/ Dentil Trim	Part Number w/ Bottom Trim	Part Number w/ Trim Strip
32"	35 1/2"	WCH32X9N	WCH32X9NK*	WCH32X9ND*	WCH32X10NBT*	WCH32X9NT*
36"	39 1/2"	WCH36X9N	WCH36X9NK*	WCH36X9ND*	WCH36X10NBT*	WCH36X9NT*
37 5/8"	41 1/8"	WCH37X9N	WCH37X9NK*	WCH37X9ND*	WCH37X10NBT*	WCH37X9NT*
40"	43 1/2"	WCH40X9N	WCH40X9NK*	WCH40X9ND*	WCH40X10NBT*	WCH40X9NT*
44"	47 1/2"	WCH44X9N	WCH44X9NK*	WCH44X9ND*	WCH44X10NBT*	WCH44X9NT*
48"	51 1/2"	WCH48X9N	WCH48X9NK*	WCH48X9ND*	WCH48X10NBT*	WCH48X9NT*
50"	53 1/2"	WCH50X9N	WCH50X9NK*	WCH50X9ND*	WCH50X10NBT*	WCH50X9NT*
54"	57 1/2"	WCH54X9N	WCH54X9NK*	WCH54X9ND*	WCH54X10NBT*	WCH54X9NT*
72"	75 1/2"	WCH72X9N	WCH72X9NK*	WCH72X9ND*	WCH72X10NBT*	WCH72X9NT*
76"	79 1/2"	WCH76X9N	WCH76X9NK*	WCH76X9ND*	WCH76X10NBT*	WCH76X9NT*
84"	87 1/2"	WCH84X9N	WCH84X9NK*	WCH84X9ND*	WCH84X10NBT*	WCH84X9NT*
204"	207 1/2"	WCH204X9N	WCH204X9NK*	WCH204X9ND*	WCH204X10NBT*	WCH204X9NT*

* Pre-Fabricated Product

[^] This part uses Keystone K9MN. Refer to page 45 for more Keystone options.



9" Crosshead

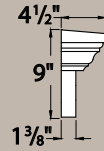

Standard



with Keystone
K9M[^]

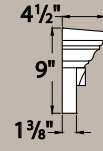

with Dentil Trim

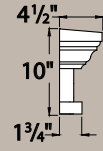

with Bottom Trim

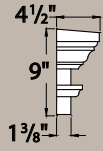

with Trim Strip

Width	Overall Width	Part Number	Part Number w/ Keystone	Part Number w/ Dentil Trim	Part Number w/ Bottom Trim	Part Number w/ Trim Strip
20"	25 1/2"	WCH20X9	WCH20X9K*	WCH20X9D*	WCH20X10BT*	WCH20X9T*
24"	29 1/2"	WCH24X9	WCH24X9K	WCH24X9D*	WCH24X10BT*	WCH24X9T*
25 5/8"	31 1/8"	WCH25X9	WCH25X9K*	WCH25X9D*	WCH25X10BT*	WCH25X9T*
26"	31 1/2"	WCH26X9	WCH26X9K*	WCH26X9D*	WCH26X10BT*	WCH26X9T*
27"	32 1/2"	WCH27X9	WCH27X9K*	WCH27X9D*	WCH27X10BT*	WCH27X9T*
28"	33 1/2"	WCH28X9	WCH28X9K*	WCH28X9D*	WCH28X10BT*	WCH28X9T*
29 5/8"	35 1/8"	WCH29X9	WCH29X9K*	WCH29X9D*	WCH29X10BT*	WCH29X9T*
30 1/4"	35 3/4"	WCH30X9	WCH30X9K*	WCH30X9D*	WCH30X10BT*	WCH30X9T*
32"	37 1/2"	WCH32X9	WCH32X9K	WCH32X9D*	WCH32X10BT	WCH32X9T*
33 5/8"	39 1/8"	WCH33X9	WCH33X9K	WCH33X9D*	WCH33X10BT*	WCH33X9T*
34"	39 1/2"	WCH34X9	WCH34X9K	WCH34X9D*	WCH34X10BT*	WCH34X9T*
35"	40 1/2"	WCH35X9	WCH35X9K*	WCH35X9D*	WCH35X10BT*	WCH35X9T*
36"	41 1/2"	WCH36X9	WCH36X9K	WCH36X9D	WCH36X10BT	WCH36X9T*
37 5/8"	43 1/8"	WCH37X9	WCH37X9K	WCH37X9D*	WCH37X10BT*	WCH37X9T*
38"	43 1/2"	WCH38X9	WCH38X9K	WCH38X9D*	WCH38X10BT	WCH38X9T*
40"	45 1/2"	WCH40X9	WCH40X9K	WCH40X9D	WCH40X10BT	WCH40X9T*
41 5/8"	47 1/8"	WCH41X9	WCH41X9K*	WCH41X9D*	WCH41X10BT	WCH41X9T*
42"	47 1/2"	WCH42X9	WCH42X9K*	WCH42X9D*	WCH42X10BT*	WCH42X9T*
43"	48 1/2"	WCH43X9	WCH43X9K	WCH43X9D*	WCH43X10BT	WCH43X9T*
44"	49 1/2"	WCH44X9	WCH44X9K	WCH44X9D	WCH44X10BT	WCH44X9T*
45"	50 1/2"	WCH45X9	WCH45X9K*	WCH45X9D*	WCH45X10BT*	WCH45X9T*
46"	51 1/2"	WCH46X9	WCH46X9K*	WCH46X9D*	WCH46X10BT*	WCH46X9T*
48"	53 1/2"	WCH48X9	WCH48X9K	WCH48X9D*	WCH48X10BT	WCH48X9T*
49"	54 1/2"	WCH49X9	WCH49X9K*	WCH49X9D*	WCH49X10BT*	WCH49X9T*

* Pre-Fabricated Product

[^] This part uses Keystone K9M. Refer to page 45 for more Keystone options.

9" Crosshead

Continued



Standard



with Keystone
K9M[^]

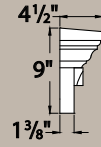

with Dentil Trim

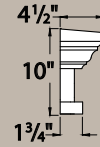

with Bottom Trim

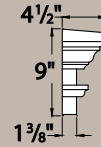

with Trim Strip

Width	Overall Width	Part Number	Part Number w/ Keystone	Part Number w/ Dentil Trim	Part Number w/ Bottom Trim	Part Number w/ Trim Strip
50"	55 1/2"	WCH50X9	WCH50X9K*	WCH50X9D*	WCH50X10BT*	WCH50X9T*
54"	59 1/2"	WCH54X9	WCH54X9K	WCH54X9D*	WCH54X10BT	WCH54X9T*
56"	61 1/2"	WCH56X9	WCH56X9K*	WCH56X9D*	WCH56X10BT	WCH56X9T*
58"	63 1/2"	WCH58X9	WCH58X9K*	WCH58X9D*	WCH58X10BT*	WCH58X9T*
60"	65 1/2"	WCH60X9	WCH60X9K*	WCH60X9D*	WCH60X10BT	WCH60X9T*
62"	67 1/2"	WCH62X9	WCH62X9K*	WCH62X9D*	WCH62X10BT*	WCH62X9T*
64"	69 1/2"	WCH64X9	WCH64X9K	WCH64X9D*	WCH64X10BT*	WCH64X9T*
65"	70 1/2"	WCH65X9	WCH65X9K*	WCH65X9D*	WCH65X10BT*	WCH65X9T*
66"	71 1/2"	WCH66X9	WCH66X9K*	WCH66X9D*	WCH66X10BT*	WCH66X9T*
67"	72 1/2"	WCH67X9	WCH67X9K*	WCH67X9D*	WCH67X10BT*	WCH67X9T*
68"	73 1/2"	WCH68X9	WCH68X9K	WCH68X9D*	WCH68X10BT	WCH68X9T*
69"	74 1/2"	WCH69X9	WCH69X9K*	WCH69X9D*	WCH69X10BT*	WCH69X9T*
70"	75 1/2"	WCH70X9	WCH70X9K*	WCH70X9D*	WCH70X10BT*	WCH70X9T*
72"	77 1/2"	WCH72X9	WCH72X9K	WCH72X9D*	WCH72X10BT	WCH72X9T*
73"	78 1/2"	WCH73X9	WCH73X9K	WCH73X9D*	WCH73X10BT*	WCH73X9T*
74"	79 1/2"	WCH74X9	WCH74X9K	WCH74X9D*	WCH74X10BT*	WCH74X9T*
75"	80 1/2"	WCH75X9	WCH75X9K*	WCH75X9D*	WCH75X10BT*	WCH75X9T*
76"	81 1/2"	WCH76X9	WCH76X9K	WCH76X9D*	WCH76X10BT	WCH76X9T*
77"	82 1/2"	WCH77X9	WCH77X9K*	WCH77X9D*	WCH77X10BT*	WCH77X9T*
78"	83 1/2"	WCH78X9	WCH78X9K	WCH78X9D*	WCH78X10BT	WCH78X9T*
80"	85 1/2"	WCH80X9	WCH80X9K	WCH80X9D*	WCH80X10BT	WCH80X9T*
81"	86 1/2"	WCH81X9	WCH81X9K*	WCH81X9D*	WCH81X10BT	WCH81X9T*
82"	87 1/2"	WCH82X9	WCH82X9K	WCH82X9D*	WCH82X10BT*	WCH82X9T*
84"	89 1/2"	WCH84X9	WCH84X9K	WCH84X9D*	WCH84X10BT	WCH84X9T*

* Pre-Fabricated Product

[^] This part uses Keystone K9M. Refer to page 45 for more Keystone options.

9" Crosshead

Continued

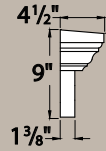

Standard



with Keystone
K9M[^]

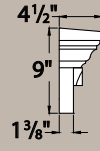

with Dentil Trim

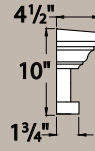

with Bottom Trim

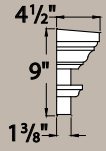

with Trim Strip

Width	Overall Width	Part Number	Part Number w/ Keystone	Part Number w/ Dentil Trim	Part Number w/ Bottom Trim	Part Number w/ Trim Strip
85"	90 1/2"	WCH85X9	WCH85X9K*	WCH85X9D*	WCH85X10BT*	WCH85X9T*
86"	91 1/2"	WCH86X9	WCH86X9K*	WCH86X9D*	WCH86X10BT	WCH86X9T*
88"	93 1/2"	WCH88X9	WCH88X9K*	WCH88X9D*	WCH88X10BT*	WCH88X9T*
90"	95 1/2"	WCH90X9	WCH90X9K*	WCH90X9D*	WCH90X10BT*	WCH90X9T*
93"	98 1/2"	WCH93X9	WCH93X9K*	WCH93X9D*	WCH93X10BT*	WCH93X9T*
96"	101 1/2"	WCH96X9	WCH96X9K	WCH96X9D*	WCH96X10BT	WCH96X9T*
99"	104 1/2"	WCH99X9	WCH99X9K	WCH99X9D*	WCH99X10BT*	WCH99X9T*
100"	105 1/2"	WCH100X9	WCH100X9K	WCH100X9D*	WCH100X10BT*	WCH100X9T*
101"	106 1/2"	WCH101X9	WCH101X9K*	WCH101X9D*	WCH101X10BT*	WCH101X9T*
103"	108 1/2"	WCH103X9	WCH103X9K*	WCH103X9D*	WCH103X10BT*	WCH103X9T*
104"	109 1/2"	WCH104X9	WCH104X9K	WCH104X9D*	WCH104X10BT	WCH104X9T*
108"	113 1/2"	WCH108X9	WCH108X9K	WCH108X9D*	WCH108X10BT	WCH108X9T*
110"	115 1/2"	WCH110X9	WCH110X9K	WCH110X9D*	WCH110X10BT*	WCH110X9T*
112"	117 1/2"	WCH112X9	WCH112X9K*	WCH112X9D*	WCH112X10BT*	WCH112X9T*
113"	118 1/2"	WCH113X9	WCH113X9K*	WCH113X9D*	WCH113X10BT*	WCH113X9T*
120"	125 1/2"	WCH120X9	WCH120X9K*	WCH120X9D*	WCH120X10BT*	WCH120X9T*
124"	129 1/2"	WCH124X9	WCH124X9K*	WCH124X9D*	WCH124X10BT*	WCH124X9T*
144"	149 1/2"	WCH144X9	WCH144X9K*	WCH144X9D*	WCH144X10BT*	WCH144X9T*
192"	197 1/2"	WCH192X9	WCH192X9K*	WCH192X9D*	WCH192X10BT*	WCH192X9T*
196"	201 1/2"	WCH196X9	WCH196X9K*	WCH196X9D*	WCH196X10BT*	WCH196X9T*
197"	202 1/2"	WCH197X9	WCH197X9K	WCH197X9D*	WCH197X10BT*	WCH197X9T*
200"	205 1/2"	WCH200X9	WCH200X9K	WCH200X9D*	WCH200X10BT	WCH200X9T*
204"	209 1/2"	WCH204X9	WCH204X9K*	WCH204X9D*	WCH204X10BT*	WCH204X9T*
207"	212 1/2"	WCH207X9	WCH207X9K*	WCH207X9D*	WCH207X10BT*	WCH207X9T*

* Pre-Fabricated Product

[^] This part uses Keystone K9M. Refer to page 45 for more Keystone options.

12" Crosshead

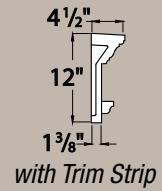
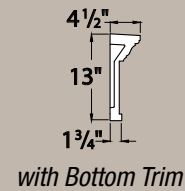
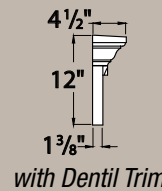
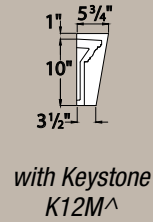
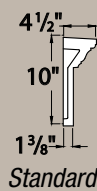

Width	Overall Width	Part Number	Part Number w/ Keystone	Part Number w/ Dentil Trim	Part Number w/ Bottom Trim	Part Number w/ Trim Strip
36"	41 1/2"	WCH36X12	WCH36X12K*	WCH36X12D*	WCH36X13BT*	WCH36X12T*
37 5/8"	43 1/8"	WCH37X12	WCH37X12K*	WCH37X12D*	WCH37X13BT*	WCH37X12T*
40"	45 1/2"	WCH40X12	WCH40X12K*	WCH40X12D*	WCH40X13BT*	WCH40X12T*
44"	49 1/2"	WCH44X12	WCH44X12K*	WCH44X12D*	WCH44X13BT*	WCH44X12T*
48"	53 1/2"	WCH48X12	WCH48X12K*	WCH48X12D*	WCH48X13BT*	WCH48X12T*
54"	59 1/2"	WCH54X12*	WCH54X12K*	WCH54X12D*	WCH54X13BT*	WCH54X12T
56"	61 1/2"	WCH56X12	WCH56X12K	WCH56X12D*	WCH56X13BT*	WCH56X12T*
64"	69 1/2"	WCH64X12	WCH64X12K*	WCH64X12D*	WCH64X13BT*	WCH64X12T*
72"	77 1/2"	WCH72X12	WCH72X12K*	WCH72X12D*	WCH72X13BT*	WCH72X12T*
96"	101 1/2"	WCH96X12	WCH96X12K*	WCH96X12D*	WCH96X13BT*	WCH96X12T*
102"	107 1/2"	WCH102X12	WCH102X12K*	WCH102X12D*	WCH102X13BT*	WCH102X12T*
104"	109 1/2"	WCH104X12	WCH104X12K*	WCH104X12D*	WCH104X13BT*	WCH104X12T*
144"	149 1/2"	WCH144X12	WCH144X12K*	WCH144X12D*	WCH144X13BT*	WCH144X12T*
200"	205 1/2"	WCH200X12	WCH200X12K*	WCH200X12D*	WCH200X13BT*	WCH200X12T*
203"	208 1/2"	WCH203X12	WCH203X12K*	WCH203X12D*	WCH203X13BT*	WCH203X12T*
213"	218 1/2"	WCH213X12	WCH213X12K*	WCH213X12D*	WCH213X13BT*	WCH213X12T*

* Pre-Fabricated Product
[^] This part uses Keystone K12M only.



14" Crosshead

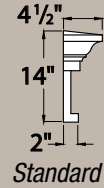

Width	Overall Width	Part Number
36"	41 1/2"	WCH36X14BT
70"	75 1/2"	WCH70X14BT
72"	77 1/2"	WCH72X14BT
76"	81 1/2"	WCH76X14BT
96"	101 1/2"	WCH96X14BT
144"	149 1/2"	WCH144X14BT

NOTE: This part only comes moulded with bottom trim.

6" Crosshead Arch

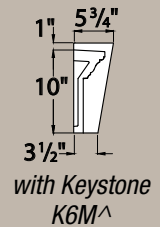
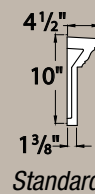

Width	Overall Width	Height	Part Number	Part Number w/ Keystone
34"	42 7/8"	10"	WCH6ARS34X10	WCH6ARS34X10K*

* Pre-Fabricated Product

^ This part uses Keystone K6M. Refer to page 45 for more Keystone options.

9" Crosshead Arch Solid

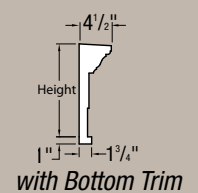
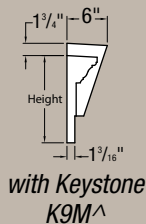
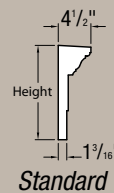

Width	Overall Width	Height	Part Number	Part Number w/ Keystone	Part Number w/ Bottom Trim
33"	48 1/16"	14"	WCHARS33X14	WCHARS33X14K*	WCHARS33X15BT*
36"	49 7/32"	13"	WCHARS36X13	WCHARS36X13K*	WCHARS36X14BT*
43"	55 1/4"	13"	WCHARS43X13	WCHARS43X13K*	WCHARS43X14BT*
54"	68 1/8"	16"	WCHARS54X16	WCHARS54X16K*	WCHARS54X17BT*

* Pre-Fabricated Product

^ This part uses Keystone K9M. Refer to page 45 for more Keystone options.

9" Crosshead Arch continued on next page

9" Crosshead Arch

Solid continued

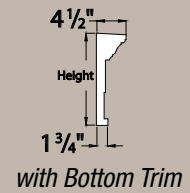
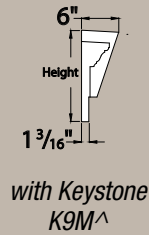
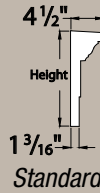

Width	Overall Width	Height	Part Number	Part Number w/ Keystone	Part Number w/ Bottom Trim
64"	75 ¹³ / ₃₂ "	14"	WCHARS64X14	WCHARS64X14K*	WCHARS64X15BT*
68"	77 ⁹ / ₃₂ "	12"	WCHARS68X12	WCHARS68X12K*	WCHARS68X13BT*
68"	80 ¹³ / ₁₆ "	16"	WCHARS68X16	WCHARS68X16K*	WCHARS68X17BT*
72"	82 ¹ / ₃₂ "	13"	WCHARS72X13	WCHARS72X13K	WCHARS72X14BT*
75"	84 ⁷ / ₈ "	13 ³ / ₈ "	WCHARS75X13	WCHARS75X13K*	WCHARS75X14BT*
80"	91 ⁹ / ₃₂ "	15"	WCHARS80X15	WCHARS80X15K*	WCHARS80X16BT*
84"	95 ²³ / ₃₂ "	16"	WCHARS84X16	WCHARS84X16K*	WCHARS84X17BT*
89"	98 ¹¹ / ₃₂ "	13"	WCHARS89X13	WCHARS89X13K*	WCHARS89X14BT*
97"	108 ¹¹ / ₁₆ "	17"	WCHARS97X17	WCHARS97X17K*	WCHARS97X18BT*
101"	110"	13"	WCHARS101X13	WCHARS101X13K*	WCHARS101X14BT*
108"	119 ²⁹ / ₃₂ "	19 ¹ / ₄ "	WCHARS108X19	WCHARS108X19K*	WCHARS108X20BT*

* Pre-Fabricated Product

[^] This part uses Keystone K9M. Refer to page 45 for more Keystone options.

10" Eyebrow Crosshead

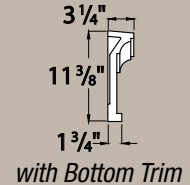
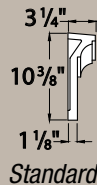

Width	Inside Width	Overall Width	Part Number	Part Number w/ Keystone	Part Number w/ Bottom Trim
37 ¹ / ₄ "	28"	41 ¹ / ₂ "	WCHSEG28X10	WCHSEG28X10K*	WCHSEG28X11BT*
39 ¹ / ₈ "	29 ⁷ / ₈ "	43 ³ / ₈ "	WCHSEG30X10	WCHSEG30X10K*	WCHSEG30X11BT*
44"	34"	48 ¹ / ₄ "	WCHSEG34X10	WCHSEG34X10K*	WCHSEG34X11BT*
45"	36"	49 ¹ / ₄ "	WCHSEG36X10	WCHSEG36X10K*	WCHSEG36X11BT*
48"	43"	52 ¹ / ₄ "	WCHSEG43X10	WCHSEG43X10K*	WCHSEG43X11BT*
44"	44"	53 ¹ / ₄ "	WCHSEG44X10	WCHSEG44X10K*	WCHSEG44X11BT*
73 ¹ / ₄ "	64"	77 ¹ / ₂ "	WCHSEG64X10	WCHSEG64X10K*	WCHSEG64X11BT*
81"	72"	85 ¹ / ₄ "	WCHSEG72X10	WCHSEG72X10K*	WCHSEG72X11BT*

* Pre-Fabricated Product

[^] This part uses Keystone K10SEG only.

8" Crosshead

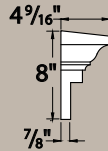

Standard

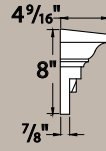

with Dentil Trim



with Bottom Trim

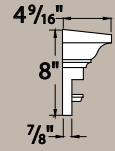

with Trim Strip

Width	Overall Width	Part Number	Part Number w/ Dentil Trim	Part Number w/ Bottom Trim	Part Number w/ Trim Strip
33"	38 1/4"	CCA33X8	CCA33X8D*	CCA33X9BT*	CCA33X8T*
40"	45 7/32"	CCA40X8	CCA40X8D*	CCA40X9BT*	CCA40X8T*

* Pre-Fabricated Product

10" Crosshead

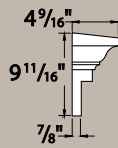

Standard



with Keystone
KCCA10^

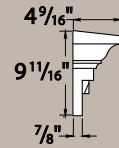

with Dentil Trim

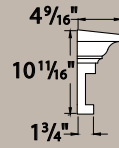

with Bottom Trim

Width	Overall Width	Part Number	Part Number w/ Keystone	Part Number w/ Dentil Trim	Part Number w/ Bottom Trim	Part Number w/ Trim Strip
32"	37 7/32"	CCA32X10	CCA32X10K*	CCA32X10D*	CCA32X11BT*	CCA32X10T*
34"	39 7/32"	CCA34X10	CCA34X10K*	CCA34X10D*	CCA34X11BT*	CCA34X10T*
36"	41 7/32"	CCA36X10	CCA36X10K*	CCA36X10D*	CCA36X11BT*	CCA36X10T*
40"	45 7/32"	CCA40X10	CCA40X10K*	CCA40X10D*	CCA40X11BT*	CCA40X10T*
47"	52 7/32"	CCA47X10	CCA47X10K*	CCA47X10D*	CCA47X11BT*	CCA47X10T*
52"	57 7/32"	CCA52X10	CCA52X10K*	CCA52X10D*	CCA52X11BT*	CCA52X10T*
64"	69 7/32"	CCA64X10	CCA64X10K*	CCA64X10D*	CCA64X11BT*	CCA64X10T*
72"	77 7/32"	CCA72X10	CCA72X10K*	CCA72X10D*	CCA72X11BT*	CCA72X10T*
100"	105 7/32"	CCA100X10	CCA100X10K*	CCA100X10D*	CCA100X11BT*	CCA100X10T*
106"	111 7/32"	CCA106X10	CCA106X10K*	CCA106X10D*	CCA106X11BT*	CCA106X10T*
199"	204 7/32"	CCA199X10	CCA199X10K*	CCA199X10D*	CCA199X11BT*	CCA199X10T*
200"	205 7/32"	CCA200X10	CCA200X10K*	CCA200X10D*	CCA200X11BT*	CCA200X10T*

* Pre-Fabricated Product

^ This part uses Keystone KCCA10 only.

8" Crosshead

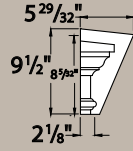

with Keystone
KCCB8[^]

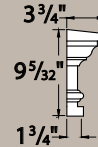

with Bottom Trim

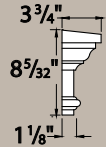

Standard with
Trim Strip

Width	Overall Width	Part Number w/ Keystone	Part Number w/ Bottom Trim	Part Number w/ Trim Strip
24"	29 1/4"	CCB24X8K* NEW	CCB24X9BT* NEW	CCB24X8 NEW
32"	37 1/4"	CCB32X8K*	CCB32X9BT*	CCB32X8
36"	41 1/4"	CCB36X8K*	CCB36X9BT	CCB36X8
40"	45 1/4"	CCB40X8K*	CCB40X9BT*	CCB40X8
64"	69 1/4"	CCB64X8K*	CCB64X9BT*	CCB64X8
101"	106 1/4"	CCB101X8K*	CCB101X9BT	CCB101X8
198"	203 1/4"	CCB198X8K*	CCB198X9BT	CCB198X8*

* Pre-Fabricated Product

[^] This part uses Keystone KCCB8 only.

8" Craftsman Crosshead

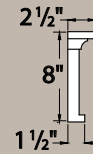

Standard

Width	Overall Width	Part Number
48"	51"	CHA48X8BT
204"	207"	CHA204X8BT

13" Craftsman Crosshead

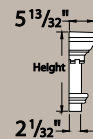

Standard

Width	Overall Width	Part Number w/ Dentil Trim & Trim Strip
82"	88 23/32"	CCC82X13

Large Door Crosshead

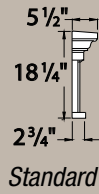

Width	Overall Width	Part Number	Pediment	Pilaster
58"	67 1/2"	LDCH58X18	SP667 Pg. 25 AP667 Pg. 28 RHP667 Pg. 28 PCP667 Pg. 29	All 11" Pilasters
62"	71 1/2"	LDCH62X18	—	
87"	96 1/2"	LDCH87X18	—	
90 1/2"	100"	LDCH90X18	—	
94 1/2"	104"	LDCH94X18	RHP6100 Pg. 29	

NOTE: Large Door Crosshead matches all 11" Pilasters.



Half-Round Sunburst

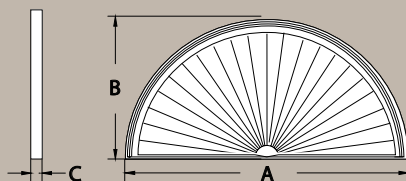

Keystone
KWM180M Page 45

Part Number	Width (A)	Height (B)	Projection (C)	Flat Trim	Decorative Trim
SWDH24X12	24"	12"	1 3/4"	AR24X4F	—
SWDH28X14	28"	14"	1 3/4"	AR28X4F	—
SWDH30X15	30"	15"	1 3/4"	—	—
SWDH32X16	32"	16"	1 3/4"	—	—
SWDH33X17	33 5/8"	16 13/16"	1 3/4"	AR33X4F	—
SWDH36X18	36"	18"	1 3/4"	AR36X4F AR36X6F	AR36X4M, AR36X6M AR36X10MC
SWDH37X19	37 5/8"	18 13/16"	1 3/4"	AR37X4F	AR37X6M
SWDH40X20	40"	20"	1 3/4"	—	AR40X6M DVP40
SWDH42X21	42"	21"	1 3/4"	—	—
SWDH44X22	44"	22"	1 3/4"	—	—
SWDH48X24	48"	24"	1 3/4"	AR48X4F AR48X6F	AR48X4M, AR48X6M AR48X10MC
SWDH52X26	52"	26"	1 3/4"	—	—
SWDH56X28	56"	28"	1 3/4"	AR56X4F	—
SWDH60X30	60"	30"	1 3/4"	AR60X6F	AR60X6M AR60X10MC
SWDH64X32	64"	32"	1 3/4"	—	AR64X10MC
SWDH68X34	68"	34"	1 3/4"	—	AR68X10MC
SWDH72X36	72"	36"	1 3/4"	AR72X4F AR72X6F	AR72X4M AR72X6M
SWDH76X38	76"	38"	1 3/4"	—	—
SWDH100X50	100"	50"	1 3/4"	—	—

Segment Sunburst

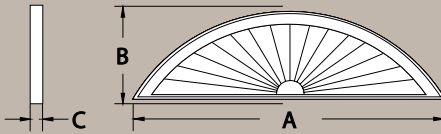

Keystone
KWM180M Page 45

Part Number	Width (A)	Height (B)	Projection (C)
SWDH36X9	36"	9"	1 3/4"
SWDH40X10	40"	10"	1 3/4"
SWDH46X13	46"	13"	1 3/4"
SWDH48X13	48"	13"	1 3/4"
SWDH54X13	54"	13"	1 3/4"
SWDH60X13	59 5/8"	12 1/2"	1 3/4"
SWDH64X13	63 5/8"	13"	1 3/4"
SWDH68X14	67 5/8"	14"	1 3/4"
SWDH72X14	72"	14"	1 3/4"
SWDH76X15	76"	15"	1 3/4"
SWDH78X16	78"	16"	1 3/4"
SWDH80X15	79 1/2"	15"	1 3/4"
SWDH96X17	95 5/16"	17"	1 3/4"
SWDH104X18	104"	18"	1 3/4"

Elliptical Sunburst

with Decorative Trim

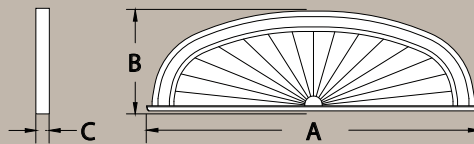

Part Number	Width (A)	Height (B)	Projection (C)
ESWDH76X23	76 7/8"	23"	3 9/16"

Half-Round Sunburst

with Flat Trim & Keystone

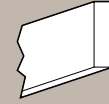
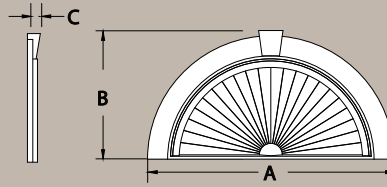

Flat Trim
FLT152

Part Number	Width (A)	Height (B)	Projection (C)
SWDH36X18-4FK	43"	22 7/16"	2 1/4"

Peaked Sunburst

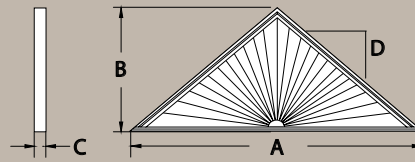

Part Number	Width (A)	Height (B)	Projection (C)	Pitch (D)
PSWDH60X30	60"	30"	1 3/4"	12 / 12
PSWDH78X32	78"	32 1/2"	1 3/4"	10 / 12
PSWDH84X28	84"	28"	1 3/4"	8 / 12

Half-Round Spoked Pediment

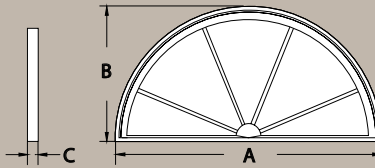

Keystone
KWM180M Page 45

Part Number	Width (A)	Height (B)	Projection (C)	Flat Trim	Decorative Trim
HRSP36X18	36"	18"	1 3/4"	AR36X4F AR36X6F	AR36X4M, AR36X6M AR36X10MC
HRSP48X24	48"	24"	1 3/4"	AR48X4F AR48X6F	AR48X4M, AR48X6M AR48X10MC
HRSP72X36	72"	36"	1 3/4"	AR72X4F AR72X6F	AR72X4M AR72X6M

Sunburst Pediment

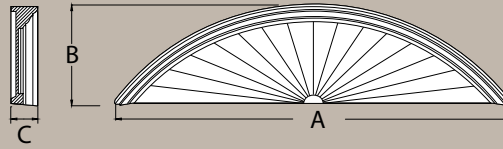

Part Number	Width (A)	Height (B)	Projection (C)	Crosshead
SP56	57"	16 ³ / ₄ "	4 ¹ / ₂ "	WCH50X9
SP667	69 ¹ / ₄ "	20 ³ / ₈ "	5 ¹ / ₂ "	LDCH58X18 LDCH62X18
SP86	87 ³ / ₁₆ "	22 ¹ / ₂ "	4 ¹ / ₂ "	WCH81X9
SP91	92 ¹ / ₂ "	26"	4 ⁵ / ₁₆ "	WCH86X9
SP98	100"	24"	4 ³ / ₈ "	WCH90X9 WCH93X9

Combination Sunburst Pediment

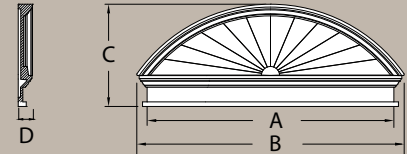
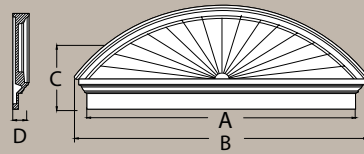

Part Number	Width (A)	Overall Width (B)	Height (C)	Projection (D)	Breastboard Thickness	Part Number w/ Bottom Trim
CSP50	50"	54 ¹ / ₂ "	20 ³ / ₄ "	3 ¹ / ₈ "	1"	CSP50BT*
CSP54	54"	58 ¹ / ₂ "	21 ³ / ₈ "	3 ¹ / ₈ "	1"	CSP54BT*
CSP75	75"	79 ⁵ / ₈ "	23 ³ / ₄ "	3 ¹ / ₈ "	1"	CSP75BT*
CSP80	80"	84 ⁵ / ₈ "	25 ¹ / ₂ "	3 ¹ / ₈ "	1"	CSP80BT
CSP85	85"	89 ¹ / ₂ "	26 ³ / ₈ "	3 ¹ / ₈ "	1"	CSP85BT

NOTE: Bottom trim adds 1" to overall height.
* Pre-Fabricated Product

Combination Acorn Pediment



NOTE: Acorn ships unattached in carton.

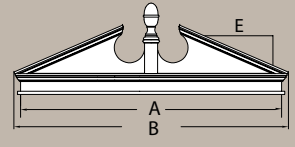
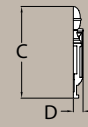
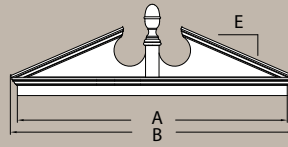
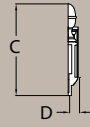

Part Number	Width (A)	Overall Width (B)	Overall Height (C)	Projection (D)	Pitch (E)	Part Number w/ Bottom Trim
CAP47E [^]	47"	50 1/8"	13 5/8"	2 1/8"	5 / 12	—
CAP50	50"	54 1/2"	21 1/8"	3 1/8"	6 / 12	CAP50BT
CAP54	54"	58 1/2"	21 3/8"	3 1/8"	6 / 12	CAP54BT
CAP58	58"	62 1/2"	21 3/4"	3 1/8"	6 / 12	CAP58BT
CAP67	67 1/2"	72"	24 1/8"	3"	6 / 12	CAP67BT
CAP75	75"	79 1/2"	25 1/8"	3 1/8"	6 / 12	CAP75BT
CAP80	80"	84 7/16"	25 3/8"	3 1/8"	5 1/2 / 12	CAP80BT
CAP85	85"	89 3/8"	28 3/4"	3 1/8"	5 / 12	CAP85BT

NOTE: Bottom trim adds 1" to overall height.

[^] Economy style; does not have breastboard. Accessories cannot be added.

Combination Peaked Cap Pediment

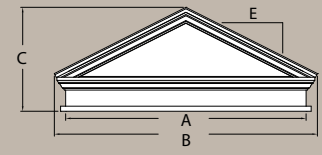
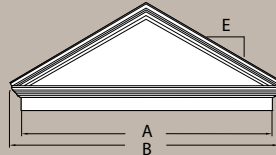
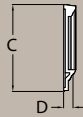

Part Number	Width (A)	Overall Width (B)	Overall Height (C)	Projection (D)	Pitch (E)	Breastboard Thickness	Part Number w/ Bottom Trim
CPCP48	47 1/2"	52"	19 1/2"	3 1/8"	6 / 12	1"	CPCP48BT
CPCP50	50"	54 1/2"	20 1/4"	3 1/8"	6 / 12	1"	CPCP50BT*
CPCP54	54"	58 1/4"	21"	3 1/8"	6 / 12	1"	CPCP54BT
CPCP58	58"	62 3/8"	22"	3 1/8"	6 / 12	1"	CPCP58BT*
CPCP67	67 1/2"	72"	24 1/2"	3 1/8"	6 / 12	1"	CPCP67BT*
CPCP75	75"	79 9/16"	26 1/4"	3 1/8"	6 / 12	1"	CPCP75BT*
CPCP80	80"	84 1/2"	27 5/8"	3 1/8"	6 / 12	1"	CPCP80BT
CPCP85	85"	89 1/2"	28 3/4"	3 1/8"	6 / 12	1"	CPCP85BT*

NOTE: Bottom trim adds 1" to overall height.

* Pre-Fabricated Product

Combination Peaked Cap Pediment

with Bottom Trim

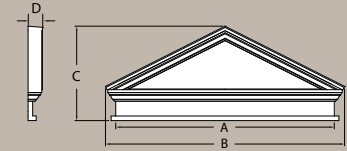
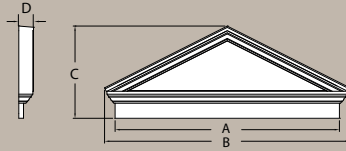

Part Number	Width (A)	Overall Width (B)	Height (C)	Projection (D)	Part Number w/ Bottom Trim
CCP37	37 5/8"	41 13/16"	20 1/2"	4 1/2"	CCP37BT*

* Pre-Fabricated Product

Combination Rams Head Pediment

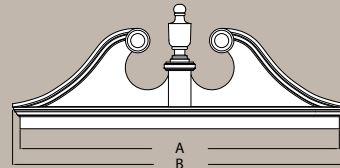

NOTE: Urn ships unattached in carton.

Part Number	Width (A)	Overall Width (B)	Overall Height (C)	Projection (D)	Breastboard Thickness	Part Number w/ Bottom Trim
CRHP50	50"	54"	23 13/16"	3 1/8"	1"	CRHP50BT*
CRHP54	54"	58"	23 1/2"	3 1/8"	1"	CRHP54BT*
CRHP67	67 1/2"	71 1/2"	27"	3 1/8"	1"	CRHP67BT*
CRHP75	75"	79"	29 1/16"	3 1/8"	1"	CRHP75BT*
CRHP80	80"	84"	35 3/4"	3 1/8"	1"	CRHP80BT*
CRHP85	85"	89"	33 9/16"	3 1/8"	1"	CRHP85BT*

NOTE: Bottom trim adds 1" to overall height.

* Pre-Fabricated Product



Combination Segment Arch Pediment

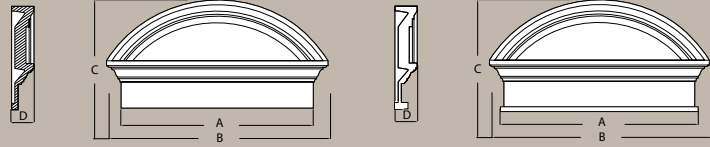

Part Number	Width (A)	Overall Width (B)	Height (C)	Projection (D)	Part Number w/ Bottom Trim
CSAP36	36"	41 1/2"	20"	4 1/2"	CSAP36BT*
CSAP38	38"	43 1/2"	20"	4 1/2"	CSAP38BT*
CSAP48	48"	53 1/2"	22 1/2"	4 1/2"	CSAP48BT*
CSAP65	65"	70 1/2"	28 3/8"	4 1/2"	CSAP65BT*
CSAP84	84"	89 1/2"	28"	4 1/2"	CSAP84BT*

* Pre-Fabricated Product

Acorn Pediment



NOTE: Acorn ships unattached in carton.

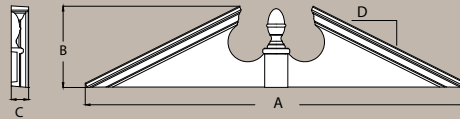

Part Number	Overall Width (A)	Overall Height (B)	Projection (C)	Pitch (D)	Crosshead
AP56	57"	16 5/8"	4 1/2"	6 1/2 / 12	WCH50X9
AP61	62"	16 3/4"	4 1/2"	7 / 12	WCH54X9 WCH56X9
AP667	68 7/8"	23 1/4"	5 1/2"	12 / 12	LDCH58X18 LDCH62X18
AP86	87 3/16"	24"	4 1/2"	7 / 12	WCH81X9
AP91	92 1/8"	24 1/2"	4 1/2"	6 / 12	WCH86X9
AP98	99 1/16"	24 1/2"	4 1/2"	6 / 12	WCH90X9 WCH93X9

Acorn Pediment

Adjustable



NOTE: Ships in 4 pieces.

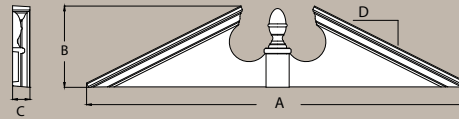

Part Number	Overall Width (A)	Overall Height (B)	Projection (C)	Pitch (D)	Crosshead
AP115	105"-115"	25 5/8"	4 1/2"	6 / 12	9" WCH from 100"-110"

Rams Head Pediment



NOTE: Urn ships unattached in carton.

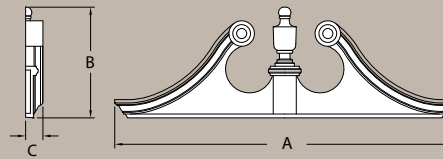

Part Number	Overall Width (A)	Overall Height (B)	Projection (C)	Crosshead
RHP56	60 7/8"	19 1/16"	4 1/2"	WCH50X9
RHP667	73 1/2"	21 7/16"	5 1/2"	LDCH58X18 LDCH62X18
RHP86	93 1/4"	29 1/2"	4 1/2"	WCH81X9
RHP6100	107 5/16"	29 3/8"	5 1/2"	LDCH90X18 LDCH94X18

Peaked Cap Pediment

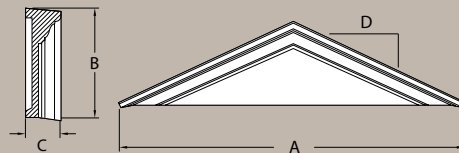

Part Number	Overall Width (A)	Overall Height (B)	Projection (C)	Pitch (D)	Crosshead
PCP56	56 7/16"	13 5/8"	4 1/2"	5 1/2 / 12	WCH50X9
PCP667	68 3/4"	23 5/8"	4 1/2"	8 / 12	LDCH58X18 LDCH62X18

Deluxe Victorian Pediment

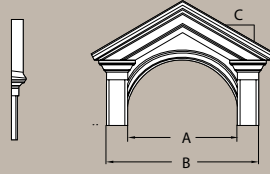

Part Number	Inside Width (A)	Inside Height	Overall Width (B)	Radius	Pitch (C)	Accessories
DVP40	40"	24 1/2"	67 1/4"	20"	7 / 12	PIL8X90P, PIL8X108P SWDH40X20

7" Panel Arch with Sunburst & Keystone

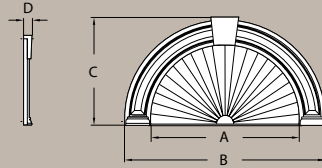

Part Number	Sunburst Width (A)	Overall Width (B)	Height (C)	Radius	Keystone Projection (D)	Pilaster
AR40X54PSK	40"	54"	29"	20"	2 5/8"	PIL7X90DP^

^ PIL7X90DP matches this arch profile *only*.

10" Decorative Arch

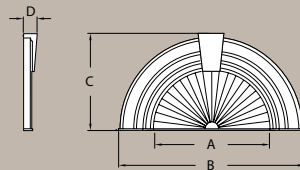

Part Number	Sunburst Width (A)	Overall Width (B)	Height (C)	Radius	Keystone Projection (D)	Pilaster
AR36X10SK	36"	56"	30 1/16"	2 3/4"	4"	PIL10X96A^ PIL10X192A^

^ This arch matches PIL10X96A and PIL10X192A *only*.



Plain Pilaster

Moulded with Plinth

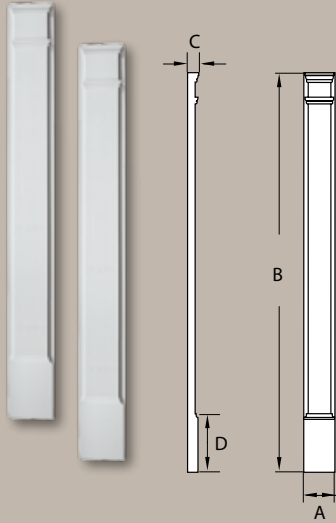

Part Number	Width (A)	Height (B)	Projection (C)	Plinth Block Height (D)
PIL5X90P	5 1/4"	90"	1 5/8"	10 1/16"
PIL6X90P	6"	90"	2 1/2"	13 3/16"
PIL7X90P	7"	90"	2 1/2"	13 3/16"
PIL8X90P	8"	90"	2 1/2"	13 3/16"
PIL9X90P	9"	90"	3"	14 1/2"
PIL11X90P	11"	90"	3 1/2"	13 3/16"

NOTE: Sold in pairs

Plain Economy Pilaster

Moulded with Plinth

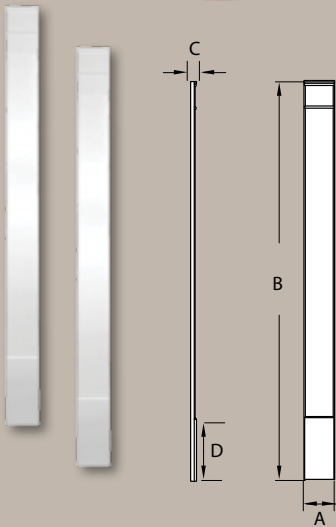

Part Number	Width (A)	Height (B)	Projection (C)	Plinth Block Height (D)
PIL7X90PE	7"	90"	1 5/16"	14 3/16"

NOTE: Sold in pairs



Plain Pilaster

Two-Piece Adjustable

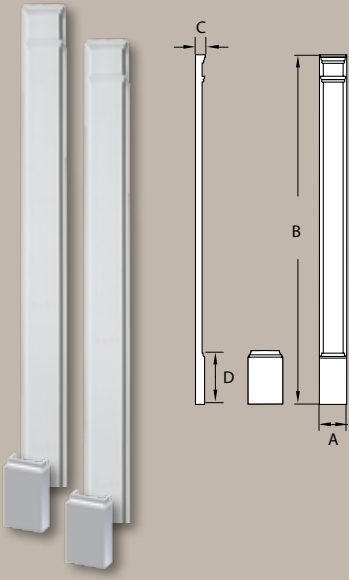

Part Number	Width (A)	Height (B)	Projection (C)	Plinth Block Height (D)
PIL5X108P	5 1/4"	108"	1 5/8"	10"
PIL6X120P	6"	120"	2 1/2"	13 3/16"
PIL7X108P	7"	108"	2 1/2"	13"
PIL7X120P	7"	120"	2 1/2"	13"
PIL8X108P	8"	108"	2 5/8"	13"
PIL9X108P	9"	108"	3"	14 1/2"
PIL9X120P	9"	120"	3"	14 1/2"
PIL10X120P	10"	120"	3 1/4"	14 1/2"
PIL11X96P	11"	96"	3 1/2"	14 1/2"
PIL11X108P	11"	108"	3 1/2"	14 1/2"
PIL11X109P	11"	109"	3 1/2"	14 1/2"
PIL11X120P	11"	120"	3 1/2"	14 1/2"

NOTE: Sold in pairs

Double Panel Pilaster

Moulded with Plinth

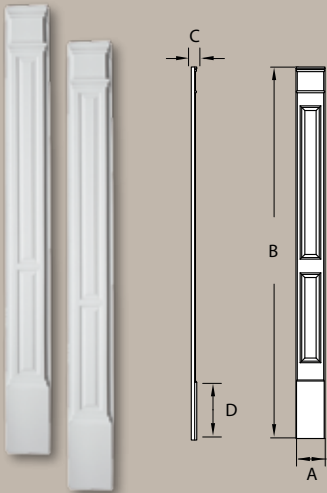

Part Number	Width (A)	Height (B)	Projection (C)	Plinth Block Height (D)
PIL5X90DP	5 1/4"	90"	1 5/8"	8"
PIL7X90DP	7"	90"	2 1/2"	13 3/16"
PIL9X90DP	9"	90"	3"	14 1/2"
PIL9X100DP	9"	100"	3"	14 1/2"
PIL11X90DP	11"	90"	3 1/2"	14 1/2"
PIL11X108DP	11"	108"	3 1/2"	14 1/2"

NOTE: Sold in pairs

Double Panel Economy Pilaster

Moulded with Plinth

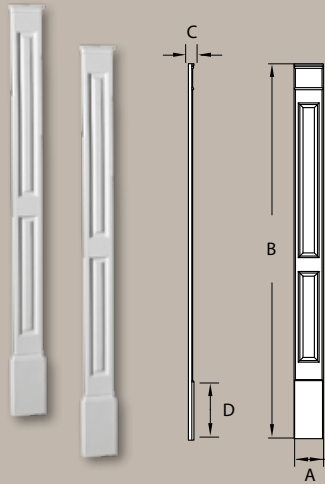

Part Number	Width (A)	Height (B)	Projection (C)	Plinth Block Height (D)
PIL7X90DPE	7"	90"	1 5/16"	14 3/16"

NOTE: Sold in pairs

Fluted Pilaster

Moulded with Plinth

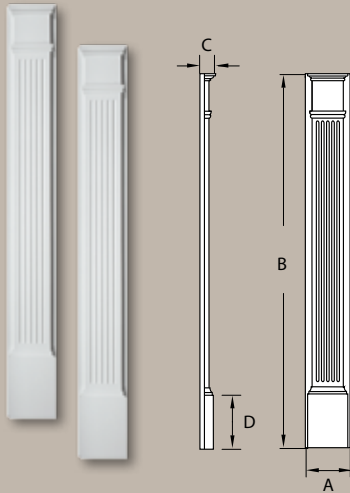

Part Number	Width (A)	Height (B)	Projection (C)	Plinth Block Height (D)
PIL3X81	3 1/2"	81"	1 1/8"	10"
PIL4X83	4 1/2"	82 3/4"	1 1/8"	7 3/4"
PIL4X86	4 1/2"	86"	1 5/8"	11"
PIL4X90	4 1/2"	90"	1 5/8"	10"
PIL5X82	5 1/4"	82"	1 5/8"	8"
PIL5X90	5 1/4"	90"	1 5/8"	10 1/8"
PIL6X90	6 1/4"	90"	2 1/2"	13 3/16"
PIL7X90	7"	90"	2 1/2"	13 3/16"
PIL9X90	9"	90"	3"	14 1/2"
PIL11X90	11"	90"	3 1/2"	14 1/2"

NOTE: Sold in pairs

Fluted Economy Pilaster

Moulded with Plinth

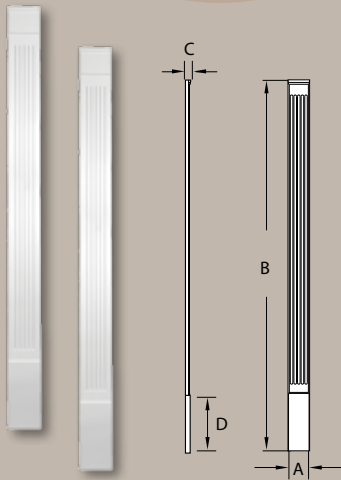

Part Number	Width (A)	Height (B)	Projection (C)	Plinth Block Height (D)
PIL3X90E	3"	90"	1 1/4"	14 3/16"
PIL5X90E	5 1/4"	90"	1 1/4"	14 3/16"
PIL7X90E	7"	90"	1 5/16"	14 3/16"
PIL9X90E	9"	90"	1 5/16"	14 3/16"

NOTE: Sold in pairs

Fluted Pilaster

Two-Piece Adjustable

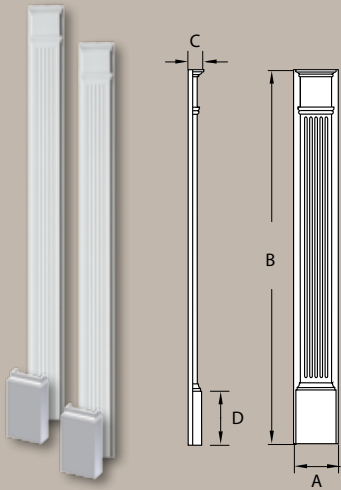

Part Number	Width (A)	Height (B)	Projection (C)	Plinth Block Height (D)
PIL3X108	3 1/2"	108"	1 5/8"	10"
PIL4X108	4 1/2"	108"	1 5/8"	10"
PIL5X108	5 1/4"	108"	1 5/8"	10"
PIL6X108	6 1/4"	108"	2 1/2"	13 3/16"
PIL6X144	6 1/4"	144"	2 1/2"	13 3/16"
PIL7X102	7"	102"	2 1/2"	13 3/16"
PIL7X108	7"	108"	2 1/2"	13"
PIL7X144	7"	144"	2 1/2"	13"
PIL8X90	8"	90"	2 1/2"	13"
PIL8X108	8"	108"	2 1/2"	13"
PIL8X144	8"	144"	2 1/2"	13"
PIL9X102	9"	102"	3"	14 1/2"
PIL9X108	9"	108"	3"	14 1/2"
PIL9X144	9"	144"	3"	14 1/2"
PIL11X108	11"	108"	3 1/2"	14 1/2"
PIL11X120	11"	120"	3 1/2"	14 1/2"
PIL11X144	11"	144"	3 1/2"	14 1/2"

NOTE: Sold in pairs

Fluted Economy Pilaster

Two-Piece Adjustable

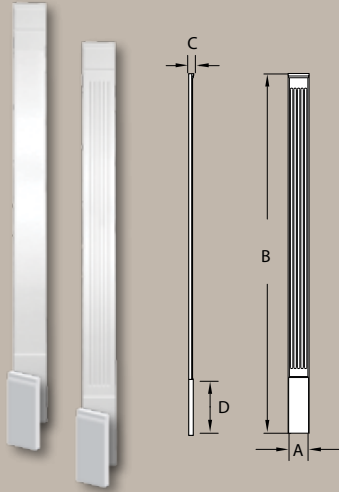

Part Number	Width (A)	Height (B)	Projection (C)	Plinth Block Height (D)
PIL5X120E	5 1/4"	120"	1 1/4"	14 3/16"
PIL7X120E	7"	120"	1 5/16"	14 3/16"

NOTE: Sold in pairs

Arch Profile Pilaster

Matches 10M Decorative Arches

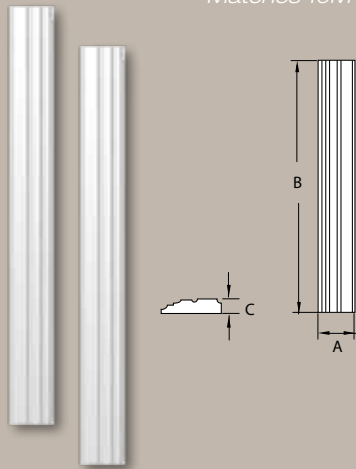

Part Number	Width (A)	Height (B)	Projection (C)
PIL10X96A	10"	96"	2 3/8"
PIL10X192A	10"	192"	2 3/8"

NOTE: Sold in pairs. See page 42 for matching arches.

Half-Round Pilaster

Adjustable Column

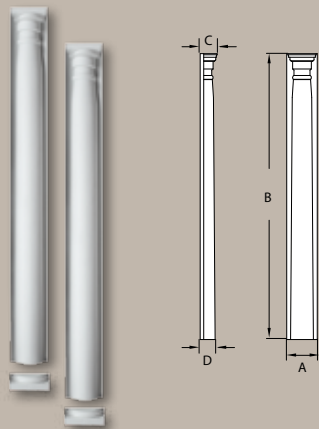

Part Number	Width (A)	Shaft Height^ (B)	Top Projection (C)	Bottom Projection (D)
PIL10X96HC	10"	93 5/8"	4 7/8"	5 17/32"

NOTE: Sold in pairs

^ Overall height is adjustable from 80"-96". Shaft sits on top of plinth, which is 3" in height.

Fluted Mull

Moulded with Plinth

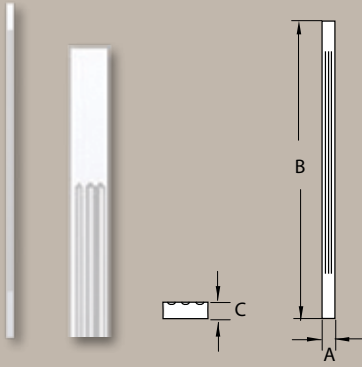

Part Number	Width (A)	Height (B)	Projection (C)
PIL2X86M	2"	86"	1"

NOTE: Sold in pairs

Fluted Panel Trim

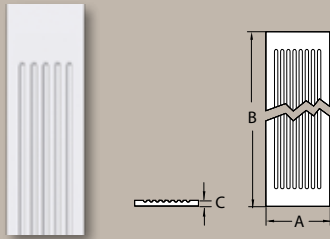

Part Number	Width (A)	Height (B)	Projection (C)
FP9X168 [^]	8 1/2"	168"	1 1/4"
FP12X96	12"	96"	1 1/2"

[^] Actual product has flutes running the full length on this size *only*.



Half-Round Arch Trim

4F Flat

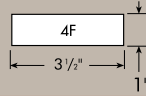
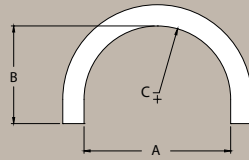

Accessories



Keystone
K4TF[^]



Keystone
KP4TF[^]



Flat Trim
FLT152



Plinth Block
PB4X4

Part Number	Inside Width (A)	Inside Height (B)	Radius (C)
AR24X4F	24 1/8"	16 1/16"	12 1/16"
AR28X4F	28 1/2"	18 1/4"	14 1/4"
AR33X4F	33 5/8"	20 13/16"	16 13/16"
AR36X4F	36"	22"	18"
AR37X4F	37 5/8"	22 13/16"	18 13/16"
AR41X4F	41 5/8"	24 13/16"	20 13/16"
AR48X4F	48"	28"	24"
AR56X4F	56 1/2"	32 1/4"	28 1/4"
AR67X4F	67 5/16"	37 21/32"	33 21/32"
AR72X4F	72"	40"	36"
AR75X4F	75 5/16"	41 21/32"	37 21/32"

[^] This part uses Keystones K4TF and KP4TF only.

Half-Round Arch Trim

4M Decorative

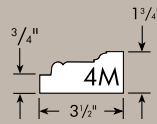
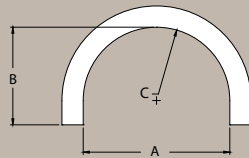

Accessories



Keystone
K4TM[^]



Keystone
KP4TM[^]



Moulding
MLD215



Plinth Block
PB215

Part Number	Inside Width (A)	Inside Height (B)	Radius (C)
AR36X4M	36"	22"	18"
AR48X4M	48"	28"	24"
AR72X4M	71 7/8"	39 15/16"	35 15/16"

[^] This part uses Keystones K4TM and KP4TM only.

Half-Round Arch Trim

6F Flat

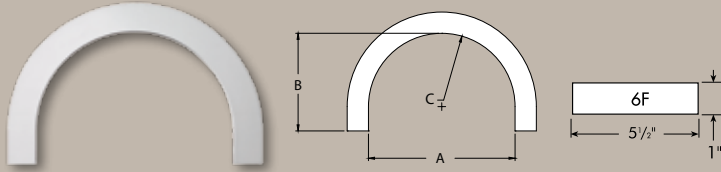

Accessories

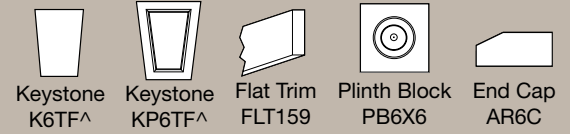

Part Number	Inside Width (A)	Inside Height (B)	Radius (C)
AR36X6F	36"	22"	18"
AR48X6F	48"	28"	24"
AR60X6F	60"	34"	30"
AR72X6F	72"	40"	36"

^ This part uses Keystones K6TF and KP6TF only.

Half-Round Arch Trim

6M Decorative

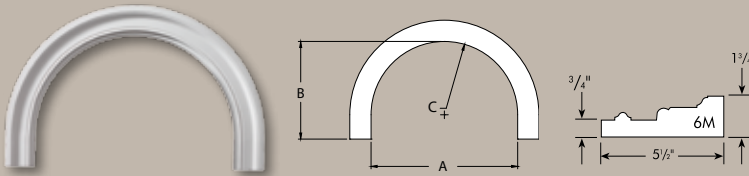

Accessories



Part Number	Inside Width (A)	Inside Height (B)	Radius (C)
AR36X6M	36"	22 1/32"	18 1/32"
AR37X6M	37 5/8"	22 13/16"	18 13/16"
AR40X6M	40"	24"	20"
AR48X6M	48"	28"	24"
AR60X6M	60"	34"	30"
AR72X6M	72"	40"	36"

^ This part uses Keystones K6TM and KP6TM only.

End Cap

for 6F & 6M Arch Trim

	Part Number	Width (A)	Projection (B)	Height (C)	
	AR6C	6"	2"	5/8"	

NOTE: Sold in pairs

Segment Arch Trim

4F, 5F & 6F Flat

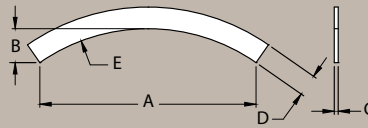

NOTE: The 4F and 6F Segment Arches ship with angled ends, as shown by the dotted lines.

Part Number	Inside Width (A)	Inside Height (B)	Projection (C)	Trim Width (D)	Radius (E)	Accessories
ARSEG54X8X4F	54 ¹⁵ / ₁₆ "	8 ⁵ / ₈ "	1"	3 ¹ / ₂ "	48 ¹ / ₁₆ "	K4TF [^] , KP4TF [^] FLT152
ARSEG66X9X4F	66 ³ / ₁₆ "	9 ¹⁵ / ₁₆ "	1"	3 ¹ / ₂ "	60 ¹ / ₁₆ "	K4TF [^] , KP4TF [^] FLT152
ARSEG78X11X4F	78 ⁵ / ₁₆ "	11 ⁹ / ₁₆ "	1"	3 ¹ / ₂ "	72 ¹ / ₁₆ "	K4TF [^] , KP4TF [^] FLT152
ARSEG48X3X5F	48"	2 ¹¹ / ₁₆ "	1"	5"	107 ⁵ / ₈ "	K5TF [^]
ARSEG78X8X5F	78"	7 ⁵ / ₁₆ "	1"	5"	107 ⁵ / ₈ "	K5TF [^]
ARSEG78X11X6F	78 ⁵ / ₁₆ "	11 ⁹ / ₁₆ "	1"	5 ¹ / ₂ "	72 ¹ / ₁₆ "	K6TF [^] , KP6TF [^] FLT159

[^] Refer to page 45 for Keystone options.

Segment Arch Solid

5F Flat

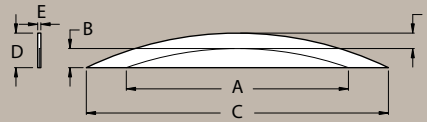

Part Number	Inside Width (A)	Inside Height (B)	Overall Width (C)	Overall Height (D)	Projection (E)	Trim Width (F)	Accessories
ARSEGS36X1X5F	36"	1 ¹ / ₂ "	75 ¹ / ₂ "	6 ¹ / ₂ "	1"	5"	K5TF [^]
ARSEGS72X6X5F	72"	6 ³ / ₁₆ "	97 ¹⁵ / ₁₆ "	11 ³ / ₁₆ "	1"	5"	K5TF [^]

[^] This part uses Keystone K5TF only.

Elliptical Trim

4F Flat

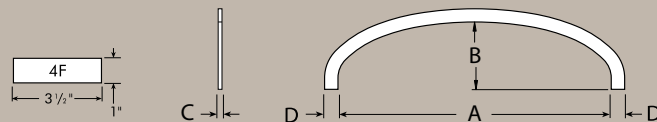

Part Number	Inside Width (A)	Inside Height (B)	Projection (C)	Trim Width (D)	Accessories
AR72X4FET	71 ³ / ₈ "	17 ²⁹ / ₃₂ "	1"	3 ¹ / ₂ "	K4TF [^] KP4TF [^]

[^] This part uses Keystones K4TF and KP4TF only.

Circle Trim

4F Flat

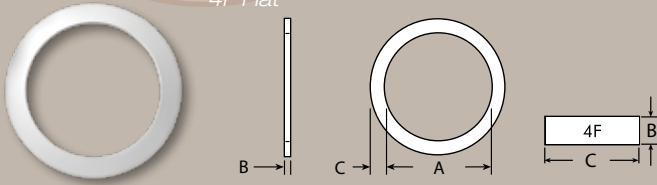

Part Number	Inside Width (A)	Projection (B)	Trim Width (C)
CIR24X4F	24 1/4"	1"	3 1/2"
CIR36X4F	36 1/16"	1"	3 1/2"

Oval Trim

4F Flat

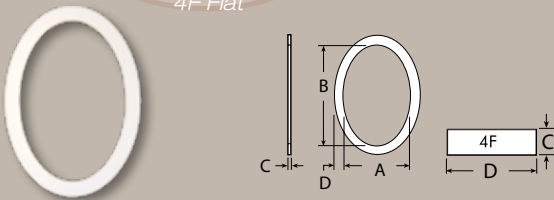

Part Number	Inside Width (A)	Inside Height (B)	Projection (C)	Trim Width (D)
OV20X28X4F	19 7/8"	28 1/2"	1"	3 1/2"
OV24X36X4F	24 1/8"	36 1/16"	1"	3 1/2"

Oval Trim

4M Decorative

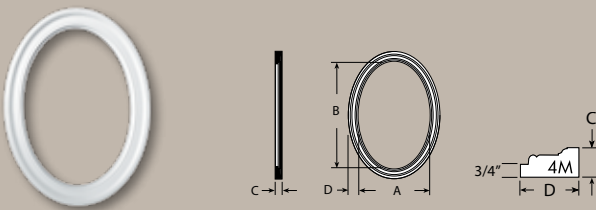

Part Number	Inside Width (A)	Inside Height (B)	Projection (C)	Trim Width (D)
OV24X36X4M	24 1/8"	36 1/16"	1 3/4"	3 1/2"

Half-Round Arch Trim

10M Decorative

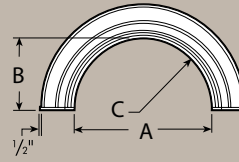
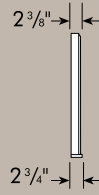

Accessories

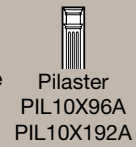

Part Number	Inside Width (A)	Inside Height (B)	Radius (C)
AR36X10MC	36"	18 3/4"	18"
AR48X10MC	48"	24 3/4"	24"
AR60X10MC	60"	30 3/4"	30"
AR64X10MC	64"	32 3/4"	32"
AR68X10MC	68"	34 3/4"	34"

Half-Round Arch with Flankers

10M Decorative

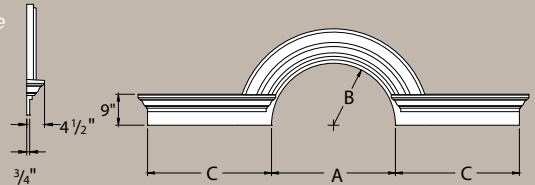

Part Number	Inside Width (A)	Inside Height / Radius (B)	Flanker Width (C)	Overall Width (D)	Accessories
AR36X10MFL108	36"	18"	36"	108"	K10TM SWDH36X18

Window Panel

Flat Panel

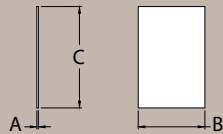

Part Number	Thickness (A)	Height (B)	Length (C)
FLT40X96	1"	40"	96"
WDP48X73F	1 1/8"	48"	73"

Window Panel

Raised Panel

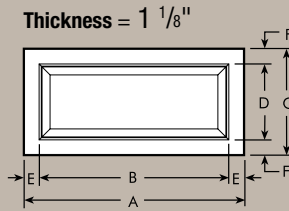

Part Number	Overall Width (A)	Panel Width (B)	Overall Height (C)	Panel Height (D)	Border Width (E)	Border Height (F)
WDP32X13	32"	23 7/8"	13"	4 7/8"	4 1/16"	4 1/16"
WDP32X21	32"	24"	21"	13"	4"	4"
WDP34X12	34 3/8"	29 3/8"	12"	7"	2 1/2"	2 1/2"
WDP36X12	36"	31"	12"	7"	2 1/2"	2 1/2"
WDP36X18	36"	28"	18"	10"	4"	4"
WDP36X24	36"	28"	23 5/8"	15 5/8"	4"	4"
WDP41X24	41 3/4"	30 1/4"	24 3/4"	13 3/4"	5 3/4"	5 1/2"
WDP44X17	44"	36"	17"	9"	4"	4"
WDP85X24	85"	81"	24"	20"	2"	2"

Window Panel

Trimable Raised Panel

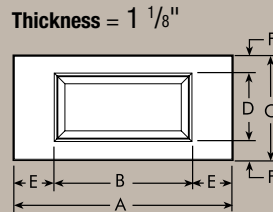

Part Number	Overall Width (A)	Panel Width (B)	Overall Height (C)	Panel Height (D)	Border Width (E)	Border Height (F)
WDP38X18ADJ	38"	24"	18"	12"	7"	3"
WDP43X13ADJ	43"	27 5/8"	13"	9 9/16"	7 11/16"	1 3/4"
WDP48X36ADJ	48"	34"	36"	28 1/2"	7"	3 3/4"

Entrance Trim Kit



Door is not included in kit.

Part Number	Kit Contents	Component Dimensions
20020 Door Trim Kit	(1) WCH54X9	9" Crosshead, 54" Width x 9" Height
	(1) PIL7X90	Pilaster Set, 7" Width x 90" Height
	(1) K9M	Keystone Coped to fit 9" Crosshead

NOTE: Ships in 4 pieces. Adjustable for door sizes 36"-40" x 80"-90"

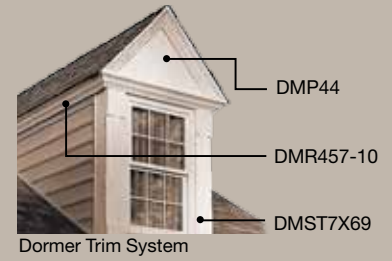

Dormer Trim System

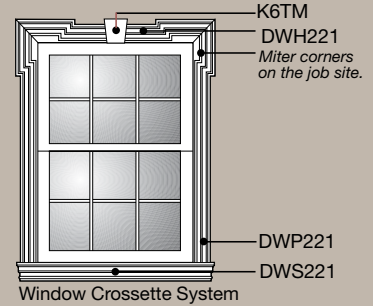

Window Crosssette System

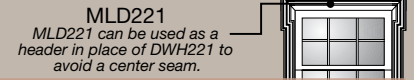











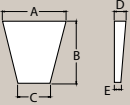

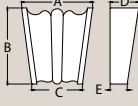

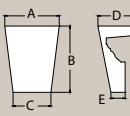

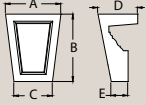
MLD221
MLD221 can be used as a header in place of DWH221 to avoid a center seam.

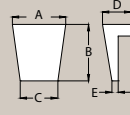
Dormer Trim System

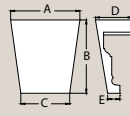
	Part Number	Width (A)	Overall Width (B)	Overall Height (C)	Projection (D)	Pitch (E)	
	DMP44 Pediment	43 3/4"	49 1/4"	33 1/4"	4 1/2"	14 / 12	
	DMST7X69 Side Trim Set	6 3/4"	—	68 5/8"	1 1/2"	—	
	DMR457-10 Return	—	—	—	—	—	

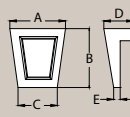
Window Crosssette System

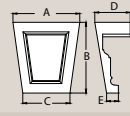
	Part Number	Width (A)	Overall Width (B)	Overall Height (C)	Projection (D)	
	DWH221 Header	132"	—	7"	1 3/4"	
	DWP221 Pilaster Set	5 1/2"	7"	114"	1 3/4"	
	DWS221 Sill	94"	96"	5 1/2"	1 3/4"	

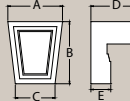

	Part Number	Top Width (A)	Bottom Width (B)	Height (C)	Top Projection (D)	Bottom Projection (E)	Arches & Trim	
	K6*	4 9/16"	2 3/4"	6 7/16"	2 3/16"	1 5/8"	—	
	K8*	9 3/4"	5 3/4"	7 3/4"	2 1/4"	1 1/4"	—	
	KD8	7"	5"	7 1/2"	2 13/16"	1 11/16"	—	
	K6M	5 3/4"	4"	7"	3 7/8"	1 1/2"	6" WCH, 6" WCH w/ BT	
	K9M	8"	6"	11"	6 1/32"	1 1/8"	9" WCH, 9" WCH w/ BT	
	K9MN	8"	6 3/16"	10"	3 7/8"	7/8"	9" Narrow WCH	
	K10SEG	8"	6"	8 1/2"	4 19/32"	3/4"	10" WCHSEG	
	K12M	8 1/2"	6"	13"	5 3/4"	2 1/8"	12" WCH	
	KCCA10	8"	6"	11"	6"	1 1/8"	10" CCA	
	KCCB8	7 23/32"	6"	9 1/2"	5 29/32"	1"	8" CCB	
	K14M	10"	8"	15"	6"	1"	14" WCH w/ BT	
	KP6M	5 3/4"	4"	7"	4 1/8"	1 3/4"	6" WCH, 6" WCH w/ BT	
	KP9M	8"	6"	11"	6 1/4"	1 5/8"	9" WCH, 9" WCH w/ BT	
	K4TF	4 1/4"	3"	4 1/2"	2 1/4"	1/2"	4F Arches FLT152	
	K5TF	6"	4"	10"	2 1/4"	1/4"	5F Trim	
	K6TF	6"	4"	7"	2 3/8"	5/8"	6F Arches FLT159	
	K8TF	7"	5"	8 7/8"	2 1/2"	3/4"	FLT162	
	K4TM	4 1/4"	3"	4 1/2"	2 1/4"	3/4"	4M Arches MLD215	
	K6TM	6"	4"	7"	2 3/8"	7/8"	6M Arches MLD220 DWH221	
	K10TM	8"	5 1/2"	11 1/2"	4"	1 3/4"	10M Arch Trim PIL10X96A PIL10X192A	
	KP4TF	4 1/4"	3"	4 1/2"	2 1/4"	1/2"	4F Arches FLT152	
	KP6TF	6"	4"	7"	2 3/8"	5/8"	6F Arches FLT159	
	KP4TM	4 1/4"	3"	4 1/2"	2 3/4"	3/4"	4M Arch Trim MLD215	
	KP6TM	6"	4"	7"	2 1/2"	7/8"	6M Arch Trim MLD220 DWH221	
	KWM180M	2 3/4"	2"	3 1/8"	2 7/16"	—	Brick Mould Louvers / Trim MLDWM180	

NOTE: Moulded on back side to fit decorative and flat trim profiles.
 * Keystones K6 and K8 are not moulded on back side.

Keystones continued on next page

Keystones

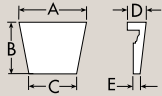
for Trim Profiles continued

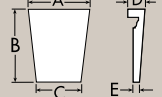
Part Number	Top Width (A)	Bottom Width (B)	Height (C)	Top Projection (D)	Bottom Projection (E)	Arches & Trim
 K226M	8 1/2"	6 1/2"	6"	2 3/8"	3/4"	MLD226 
 K227M	8 1/2"	10"	6"	2 3/8"	7/8"	MLD227 



Louvered Shutter

without Center Rail

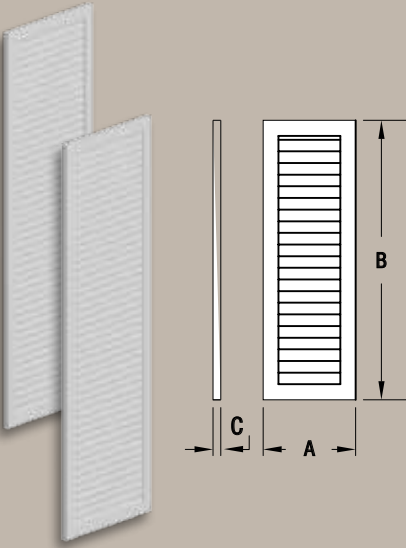

Part Number	Width (A)	Height (B)	Projection (C)
LVSH12X36FNB	12"	36"	1"
LVSH12X42FNB	12"	42"	1"
LVSH16X54FNB	16"	54"	1"
LVSH16X60FNB	16"	60"	1"
LVSH16X72FNB	16"	72"	1"
LVSH18X54FNB	18"	54"	1"
LVSH18X60FNB	18"	60"	1"
LVSH18X62FNB	18"	62"	1"
LVSH18X66FNB	18"	66"	1"
LVSH18X72FNB	18"	72"	1"
LVSH24X60FNB	24"	60"	1"
LVSH24X72FNB	24"	72"	1"

NOTE: This is a style without a centerboard.
NOTE: Sold in pairs

Louvered Shutter

with Center Rail

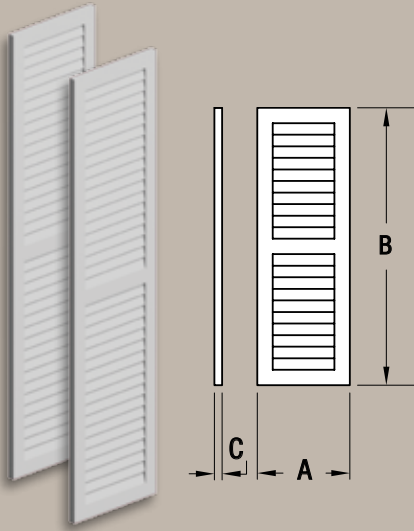

Part Number	Width (A)	Height (B)	Projection (C)
LVSH12X36FNCR	12"	36"	1"
LVSH12X42FNCR NEW	12"	42"	1"
LVSH12X48FNCR	12"	48"	1"
LVSH16X54FNCR	16"	54"	1"
LVSH16X60FNCR	16"	60"	1"
LVSH16X72FNCR	16"	72"	1"
LVSH18X60FNCR	18"	60"	1"
LVSH18X66FNCR	18"	66"	1"
LVSH18X72FNCR	18"	72"	1"
LVSH18X76FNCR	18"	76"	1"
LVSH24X60FNCR	24"	60"	1"
LVSH24X72FNCR	24"	72"	1"

NOTE: Sold in pairs

Raised Panel Shutter

Triple Panel

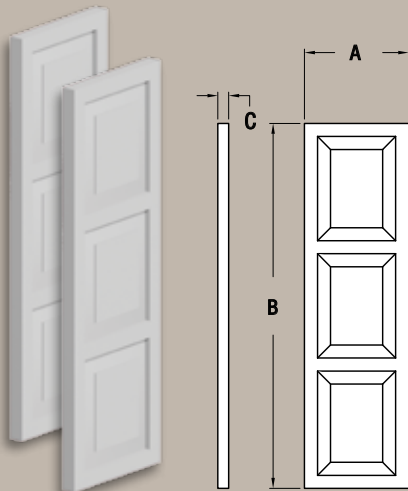

Part Number	Width (A)	Height (B)	Projection (C)
SH12X48TP	12"	48"	1 1/4"
SH12X60TP	12"	60"	1 1/4"
SH18X36TP	18"	36"	1 1/4"
SH18X42TP	18"	42"	1 1/4"
SH18X48TP	18"	48"	1 1/4"
SH18X54TP	18"	54"	1 1/4"
SH18X60TP	18"	60"	1 1/4"
SH18X72TP	18"	72"	1 1/4"

NOTE: Sold in pairs

Raised Panel Shutter

Double Panel

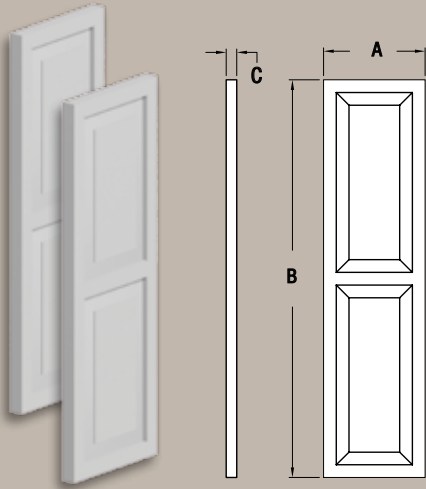

Part Number	Width (A)	Height (B)	Projection (C)
SH16X48DP	16"	48"	1 1/4"
SH16X54DP	16"	54"	1 1/4"
SH16X60DP	16"	60"	1 1/4"
SH16X65DP	16"	65"	1 1/4"
SH16X72DP	16"	72"	1 1/4"
SH18X53DP	18"	53"	1 1/4"
SH18X59DP	18"	59"	1 1/4"
SH18X66DP	18"	66"	1 1/4"
SH18X72DP	18"	72"	1 1/4"

NOTE: Sold in pairs

Shutter Accessories

	Part Number	Width	Shutter	
	SHAC19174	16"	All 16" Louvered Shutters	
	SHAC19153	16"	All 16" Raised Panel Shutters	
	SHAC19165	12"	All 12" Raised Panel Shutters	
	SHAC19167	16"	All 16" Raised Panel Shutters	
	SHAC19169	18"	All 18" Raised Panel Shutters	

NOTE: Sold in pairs

Timber Board Shutter

Stainable

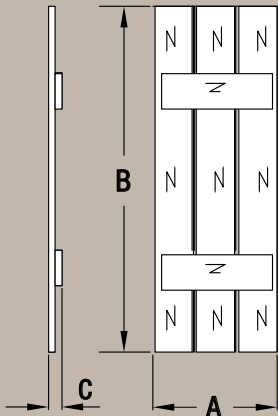

Part Number	Width (A)	Height (B)	Projection (C)
SH3PC14X39S	14"	39"	1 1/2"
SH3PC14X47S	14"	47"	1 1/2"
SH3PC14X55S	14"	55"	1 1/2"
SH3PC14X59S	14"	59"	1 1/2"
SH3PC14X63S	14"	63"	1 1/2"
SH3PC16X36S	16"	36"	1 1/2"
SH3PC16X42S	16"	42"	1 1/2"
SH3PC16X48S	16"	48"	1 1/2"
SH3PC16X54S	16"	54"	1 1/2"
SH3PC16X60S	16"	60"	1 1/2"
SH3PC16X72S	16"	72"	1 1/2"
SH3PC18X42S	18"	42"	1 1/2"
SH3PC18X48S	18"	48"	1 1/2"
SH3PC18X60S	18"	60"	1 1/2"
SH3PC18X66S	18"	66"	1 1/2"
SH3PC18X72S	18"	72"	1 1/2"
SH3PC18X84S	18"	84"	1 1/2"
SH3PC24X48S	24"	48"	1 1/2"
SH3PC24X60S	24"	60"	1 1/2"
SH3PC24X66S	24"	66"	1 1/2"
SH3PC24X72S	24"	72"	1 1/2"
SH3P3BC14X71S^	14"	71"	1 1/2"
SH3P3BC14X75S^	14"	75"	1 1/2"

NOTE: Sold in pairs
 ^ These items have 3 boards and 3 battens.

Timber Elliptical Top Shutter

Stainable

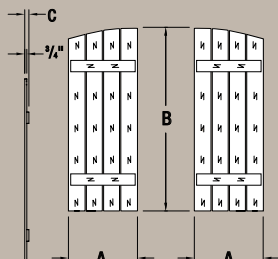

Part Number	Width (A)	Height (B)	Projection (C)	No. of Boards
SH4PHLR24X60S	24"	60"	1 1/2"	4
SH4PHLR24X64S	24"	64"	1 1/2"	4

NOTE: Sold in pairs

Timber Arch Top Shutter

Stainable

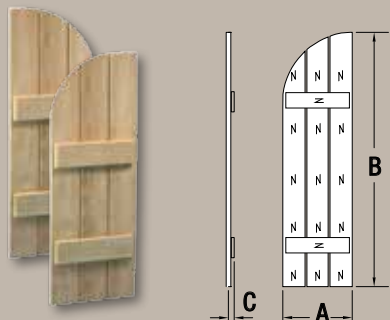

Part Number	Width (A)	Height (B)	Projection (C)	No. of Boards
SH2PHLR12X48S	12"	48"	1 1/2"	2
SH3PHLR18X66S	18"	66"	1 1/2"	3
SH3PHLR24X70S	24"	70"	1 1/2"	3
SH3PHLR24X86S	24"	86"	1 1/2"	3
SH4PHLR24X82S	24"	82"	1 1/2"	4

NOTE: Sold in pairs

Timber Board Shutter

Stainable with Border

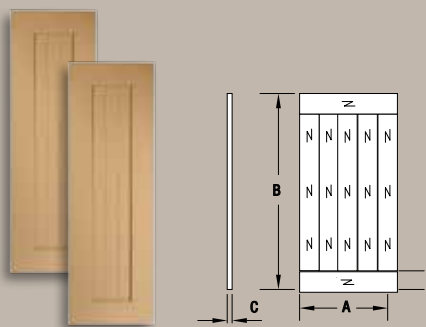

Part Number	Width (A)	Height (B)	Projection (C)
SH3PB15X46S	15"	46"	1"
SH3PB18X40S	18"	40"	1"
SH3PB18X66S	18"	66"	1"
SH3PB24X54S	24"	54"	1"

NOTE: Sold in pairs

Timber Louvered Shutter

Stainable with Center Rail

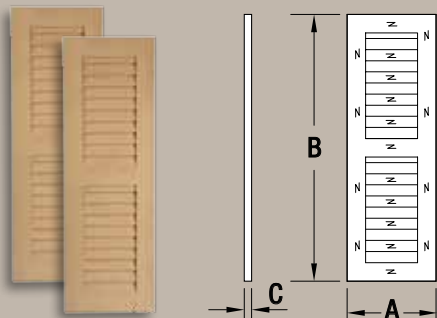

Part Number	Width (A)	Height (B)	Projection (C)
LVSH12X36FNCR3S	12"	36"	1"
LVSH12X48FNCR3S	12"	48"	1"
LVSH16X48FNCR3S	16"	48"	1"
LVSH16X60FNCR3S	16"	60"	1"
LVSH18X48FNCR4S	18"	48"	1"
LVSH18X60FNCR4S	18"	60"	1"

NOTE: Sold in pairs

Timber Plank Shutter

Stainable

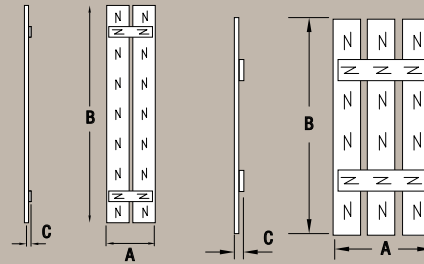

Part Number	Width (A)	Height (B)	Projection (C)	No. of Boards
SH2P012X36S	12"	36"	1 1/2"	2
SH2P012X42S	12"	42"	1 1/2"	2
SH2P012X48S	12"	48"	1 1/2"	2
SH2P012X54S	12"	54"	1 1/2"	2
SH3P016X36S	16"	36"	1 1/2"	3
SH3P016X42S	16"	42"	1 1/2"	3
SH3P016X48S	16"	48"	1 1/2"	3
SH3P016X54S	16"	54"	1 1/2"	3
SH3P016X60S	16"	60"	1 1/2"	3
SH3P016X72S	16"	72"	1 1/2"	3
SH3P018X36S	18"	36"	1 1/2"	3
SH3P018X48S	18"	48"	1 1/2"	3
SH3P018X54S	18"	54"	1 1/2"	3
SH3P018X60S	18"	60"	1 1/2"	3
SH3P018X62S	18"	62"	1 1/2"	3
SH3P018X66S	18"	66"	1 1/2"	3
SH3P018X72S	18"	72"	1 1/2"	3
SH3P020X42S	20"	42"	1 1/2"	3
SH3P020X48S	20"	48"	1 1/2"	3
SH3P020X54S	20"	54"	1 1/2"	3
SH3P020X66S	20"	66"	1 1/2"	3

NOTE: Sold in pairs

Timber Plank Shutter

Stainable with Diamond

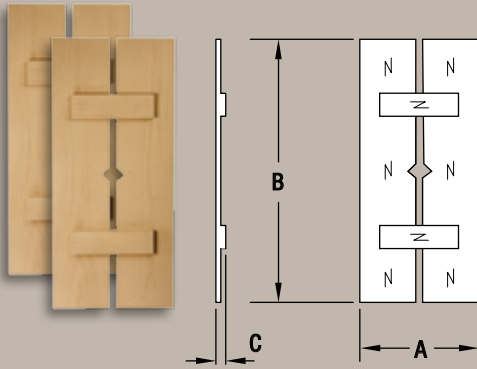

Part Number	Width (A)	Height (B)	Projection (C)
SH2PD18X40S	18"	40"	1 1/2"
SH2PD18X48S	18"	48"	1 1/2"
SH2PD18X60S	18"	60"	1 1/2"
SH2PD18X66S	18"	66"	1 1/2"
SH2PD24X48S	24"	48"	1 1/2"
SH2PD24X54S	24"	54"	1 1/2"

NOTE: Sold in pairs

Timber Board Panels

Stainable for Shutter Fabrication

Part Number	Width (A)	Length (B)	Projection (C)
 SH3PCPL14X88S 3-Board Panel	14"	88"	3/4"
 SH4P24X144X2S 4-Board Panel	24"	144"	2"
 SH5P30X144S 5-Board Panel	29 3/4"	144"	3/4"

NOTE: Timber board panels sold in individual sheets

Timber Louvered Panels

Stainable for Shutter Fabrication

Part Number	Width (A)	Length (B)	Projection (C)
 LVSSNN32X144S	32"	144"	21/32"

NOTE: Timber louvered panels sold in individual sheets

Timber Square Pot Shelf

Stainable with Corbels

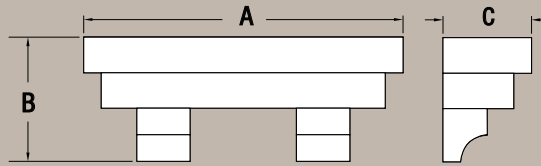

Part Number	Overall Width (A)	Overall Height (B)	Projection (C)	No. of Corbels	Accessories
PS24X14S	24"	14"	10"	2	PSBLK5X6X6S
PS36X8S	36"	14"	10"	2	
PS48X14S	48"	14"	10"	2	
PS52X14S	52"	14"	10"	3	
PS56X14S	56"	14"	10"	3	
PS72X14S	72"	14"	10"	3	
PS84X14S	84"	14"	10"	3	

NOTE: Product has open cavity.

Timber Square Pot Shelf

Stainable

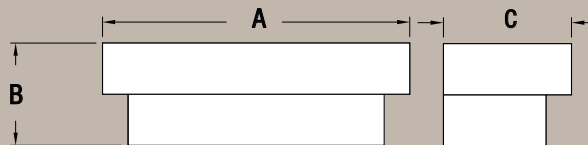

Part Number	Overall Width (A)	Overall Height (B)	Projection (C)
PS24X8S	24"	8"	10"
PS36X8NS	36"	8"	10"
PS48X8S	48"	8"	10"
PS52X8S	52"	8"	10"
PS56X8S	56"	8"	10"
PS72X8S	72"	8"	10"
PS84X8S	84"	8"	10"

NOTE: Product has open cavity.

Timber Tapered Pot Shelf

Stainable with Corbels

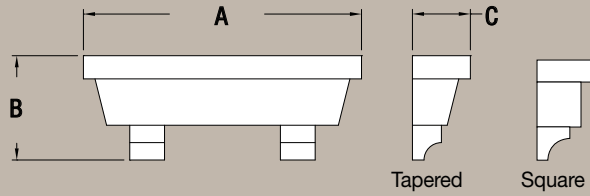

Part Number	Overall Width (A)	Overall Height (B)	Projection (C)	No. of Corbels	Shelf Block
PS48X18S	48"	18"	10"	2	PSBLK5X6X6S
PS52X18S	52"	18"	10"	2	PSBLK5X6X6S
PS54X18S	54"	18"	10"	2	PSBLK3X5X6S
PS60X18S^	60"	18"	10"	2	PSBLK3X5X6S
PS68X18S	68"	18"	10"	2	PSBLK5X6X6S
PS72X18S^	72"	18"	10"	2	PSBLK6X6X6S
PS108X18S^	108"	18"	10"	3	PSBLK3X5X6S
PS122X18S	122"	18"	10"	4	PSBLK5X6X6S

^ Matches square profile
NOTE: Product has open cavity.

Timber Tapered Pot Shelf

Stainable

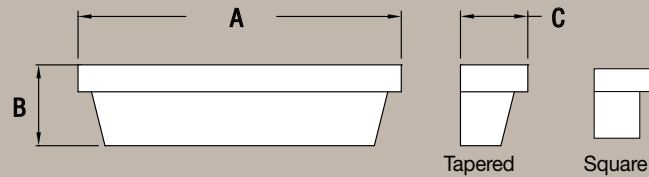

Part Number	Overall Width (A)	Overall Height (B)	Projection (C)
PS48X12S	48"	12"	10"
PS52X12S	52"	12"	10"
PS54X12S	54"	12"	10"
PS60X12S	60"	12"	10"
PS68X12S	68"	12"	10"
PS72X12S^	72"	12"	10"
PS108X12S	108"	12"	10"
PS122X12S	122"	12"	10"

^ Matches square profile
NOTE: Product has open cavity.

Timber Pot Shelf Block

Stainable

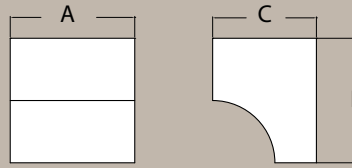

Part Number	Width (A)	Height (B)	Projection (C)
PSBLK3X5X6S	6"	5"	3"
PSBLK5X6X6S	6"	6"	5"
PSBLK6X6X6S	6"	6"	6"

Timber Sill Moulding

Stainable with Taper and Drop Edge

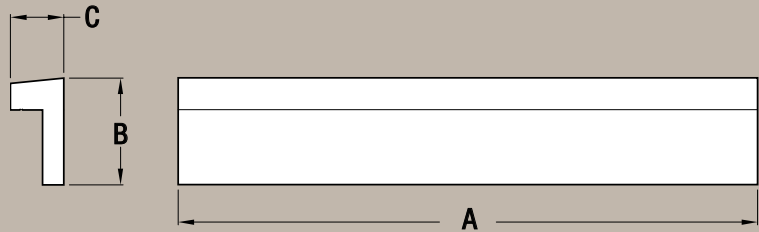

Part Number	Length (A)	Height (B)	Projection (C)
PS192X5S	192"	5"	2 1/2"

Timber Buried Header

Stainable

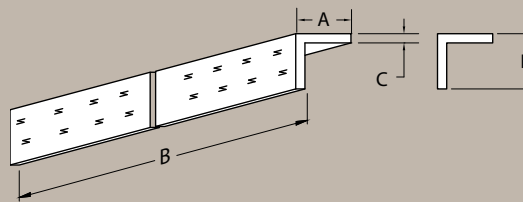

Part Number	Projection (A)	Length (B)	Thickness (C)	Height (D)
MLD388-12S	6"	12'	1"	6"
MLD398-12S	8"	12'	1"	10"
MLD399-12S	8"	12'	1"	14"
MLD397-12S	10"	12'	1"	16"

Stone Flat Block Sill

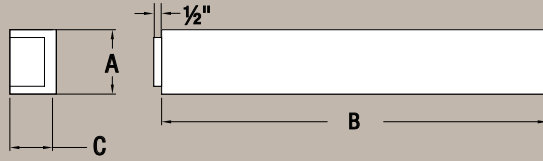

Part Number	Width (A)	Length (B)	Projection (C)
SL3X4X24ST	4 1/16"	24 3/8"	2 11/16"
SL4X4X24ST	4 1/16"	24 3/8"	4 1/16"

Stone Flat Block Sill

5 Degree Slope

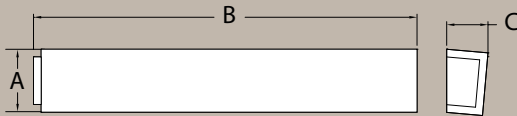

Part Number	Width (A)	Length (B)	Projection (C)
SL4X4X24ST-5	4 1/16"	24 3/8"	4 1/16"

Stone 8" Pot Shelf

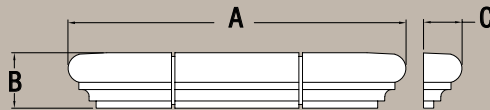

Part Number	Overall Width (A)	Overall Height (B)	Projection (C)
PS48X8ST	47 1/2"	7 9/16"	5 7/16"

Stone 13" Pot Shelf

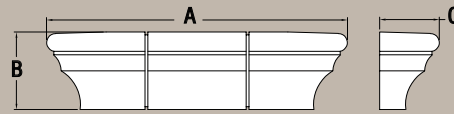
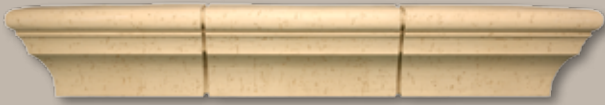

Part Number	Overall Width (A)	Overall Height (B)	Projection (C)
PS52X13ST	52 1/8"	13 7/16"	10 5/16"
PS54X13ST	53 27/32"	12 11/16"	9 1/8"
PS84X13ST	84 3/16"	13 7/16"	10 5/16"



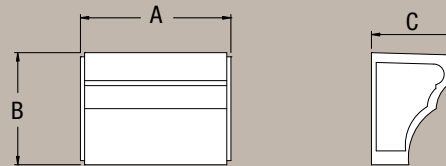





Stone 13" Pot Shelf Section



Part Number	Overall Width (A)	Overall Height (B)	Projection (C)
PS28X13ST	27 23/32"	13 7/16"	10 5/16"



Stone Arched Blocks

	Part Number	Inside Radius (A)	Inside Width (B)	Overall Height (C)	Trim Width (D)	Projection (E)	Accessories
	AR23X7ST	20 ²¹ / ₃₂ "	22 ³ / ₈ "	10 ¹ / ₄ "	6 ³¹ / ₃₂ "	2 ⁷ / ₁₆ "	FLBST3X7X24 FLBST3X7X96
	AR25X10X3ST	24 ³ / ₈ "	24 ⁵ / ₈ "	13 ¹ / ₈ "	9 ¹³ / ₁₆ "	2 ⁵ / ₈ "	FLBST3X10X24 FLBST3X10X96
	AR25X10ST	24 ³ / ₈ "	24 ⁵ / ₈ "	13 ¹ / ₈ "	9 ¹³ / ₁₆ "	4 ¹ / ₁₆ "	FLBST4X10X24 FLBST4X10X96
	AR24X9ST	32 ¹⁵ / ₃₂ "	23 ¹¹ / ₁₆ "	9 ³ / ₁₆ "	6 ³¹ / ₃₂ "	3 ⁷ / ₈ "	FLBST4X7X24 FLBST4X7X96
	AR24X11ST	34 ¹⁷ / ₃₂ "	24 ¹ / ₈ "	11 ¹ / ₈ "	8 ³¹ / ₃₂ "	2 ⁵ / ₈ "	FLBST3X9X96
	ARTD28X9X3ST	49 ¹ / ₈ "	27 ³ / ₄ "	11 ¹ / ₄ "	9 ¹ / ₄ "	2 ⁵ / ₈ "	—
	AR72X23ST	57 ¹⁷ / ₃₂ "	72 ³ / ₈ "	22 ³ / ₄ "	9 ¹⁵ / ₁₆ "	3 ⁷ / ₈ "	FLBST4X10X24 FLBST4X10X96
	AR24.625X7ST	64 ¹ / ₁₆ "	24 ⁵ / ₈ "	8 ¹ / ₁₆ "	6 ⁷ / ₈ "	2 ¹¹ / ₁₆ "	FLBST3X7X24 FLBST3X7X96
	AR24X4ST	113 ²³ / ₃₂ "	23 ³ / ₄ "	4 ¹⁹ / ₃₂ "	3 ³¹ / ₃₂ "	2 ⁷ / ₁₆ "	SL3X4X24ST

Stone Decorative Blocks

24" Section

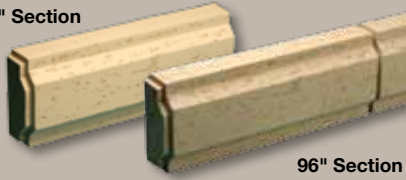

96" Section

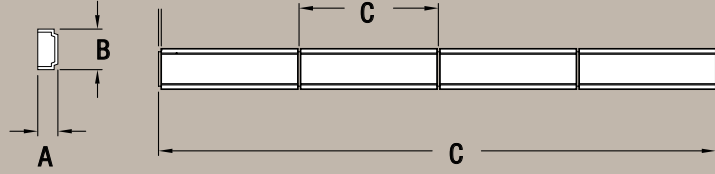

Part Number	Projection (A)	Width (B)	Length (C)
TD4X7X96ST	3 7/16"	6 31/32"	96"
TD4X9X24ST	3 7/8"	8 31/32"	24"
TD4X9X96ST	3 7/8"	8 31/32"	96"

Stone Flat Blocks

24" Section





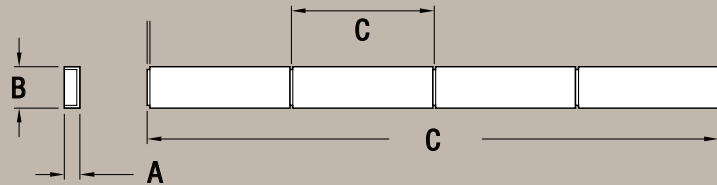

96" Section



Part Number	Projection (A)	Width (B)	Length (C)	Accessories
FLBST3X7X24	2 5/8"	6 31/32"	24"	AR23X7ST AR24.625X7ST
FLBST3X7X96	2 5/8"	6 31/32"	96"	AR23X7ST AR24.625X7ST
FLBST3X9X96	2 5/8"	8 31/32"	96"	AR24X11ST
FLBST3X10X24	2 5/8"	9 15/16"	24"	AR25X10X3ST
FLBST3X10X96	2 5/8"	9 15/16"	96"	AR25X10X3ST
FLBST4X7X24	3 7/8"	6 31/32"	24"	AR24X9ST
FLBST4X7X96	3 7/8"	6 31/32"	96"	AR24X9ST
FLBST4X9X24	3 7/8"	8 31/32"	24"	—
FLBST4X9X96	3 7/8"	8 31/32"	96"	—
FLBST4X10X24	3 7/8"	9 15/16"	24"	AR25X10ST AR72X23ST
FLBST4X10X96	3 7/8"	9 15/16"	96"	AR25X10ST AR72X23ST

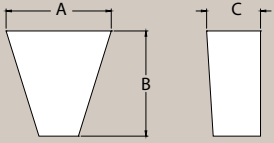

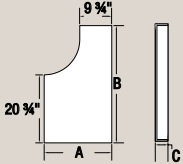
Stone Surround Accessories

	Part Number	Width (A)	Height (B)	Projection (C)	
	K10ST Keystone	9 15/16"	9 15/16"	5 15/32"	
	ARCHPLST36X21X4 Left Plinth	20 5/8"	35 13/16"	3 7/8"	
	ARCHPRST36X21X4 Right Plinth	20 5/8"	35 13/16"	3 7/8"	